

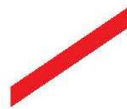





2018 v1



INDEX

<ul style="list-style-type: none"> • TECHNICAL INFORMATION Diamond grits table Diamond wheels description Dimensional information 	p. 6
<ul style="list-style-type: none"> • DRILLS Segmented drills for Granite/Marble Continuous rim drills for Granite/Marble Dead hole drills for Granite L1-55 Dead hole drills for Granite L1-40 	p. 7
<ul style="list-style-type: none"> • ROUTERS AND STEP CUT BIT Application chart Black Storm Gold - Long life Green Blue Electroplated Granite routers diameter 24 mm Vacum Brazed Routers for Marble and Stone Step cut bit Bit Holder 1/2" GAS for step cut bit Holders for block stone cone ISO40 for step cut bit Electroplated routers for marble with changeable head Body router with electroplated diamond 1/2"GAS connection Changeable head Left Drills (SX) Left Routers and Left step cut bit 	p. 9
<ul style="list-style-type: none"> • PERIPHERAL WHEELS FOR CNC MACHINES CALIBRATING WHEELS Power edge Hyper Speed Line for granite and engineered stone 	 p. 14
<ul style="list-style-type: none"> • CORNER BREAKERS Segmented corner breaker profile X Hyper speed line for granite and engineered stone Segmented corner breaker profile Y Hyper speed line for granite and engineered stone 	 p. 15
<ul style="list-style-type: none"> • WHEELS FOR EDGE PROFILING Diamond and polishing wheels range for granite and engineered stone Diamond wheels hyper speed line for granite and engineered stone FLASH polishing rubber wheels for granite, marble and engineered stone Grinding service Wheels diameter 120 mm bore 35 mm Available Shapes On Catalogue Wheels diameter 80 mm bore 35 mm Available Shapes On Catalogue Wheels diameter 40 mm bore 22 mm Available Shapes On Catalogue Wheels for inner sink hole 1/2"GAS connection Available Shapes On Catalogue Peripheral wheels for marble Electroplated and polishing wheels range for marble Abrasive polishing wheel Available Shapes On Catalogue 	 p. 16 p. 17 p. 18 p. 37 p. 47 p. 50 p. 55

INDEX

- **CHAMFERING WHEELS** p. 59
 - Diamond wheels for arris
 - Distance rings
 - Adapter for opposite mounting
- **KITCHEN TOP**
 - Recess drain working process
 - Multipurpose set for granite, marble and engineered stone with chamfer 60 degrees
 - Wheels replacement
 - Holder replacement
 - Wheels with magnetic connection
 - Set for granite with chamfer 60 degrees
 - Wheels replacement
 - Holder replacement
 - Drain groove
 - Drain groove routers Ø 10 mm 1/2"GAS connection
 - Drain groove routers Ø 12 mm 1/2"GAS connection
 - Drain groove routers Ø 14 mm 1/2"GAS connection
 - Drain groove routers Ø 20 mm 1/2"GAS connection
 - Drain grooves grooving wheels diameter 140 mm hole 30 mm for Itermac machine
 - Drain grooves grooving wheels diameter 140 mm hole 22 mm for Bimatech machine
 - Drain grooves grooving wheels diameter 180 mm hole 22 mm for Bimatech machine
- **STUBBING WHEELS**
 - Stubbing wheels standard segments for granite and engineered stone
 - Stubbing wheels standard segments for soft granite and abrasive stone
 - Stubbing wheels for high removal granite and engineered stone
 - Stubbing wheels Viper type for granite and engineered stone
 - Electroplated stubbing wheels for marble
 - Stubbing wheels extensions
 - 1/2"GAS connection
 - Block stone connection for cone ISO40
 - Block stone connection for cone ISO40 NIPL0Y processing anticorrosion
 - Block stone connection for cone ISO50 for stubbing wheels and 1/2"GAS connection
- **TOOLS FOR WRITING** p. 67
 - Writing bit in tungsten carbide for marble
 - Writing bit in PCD for granite
- **TOOLS FOR ENGRAVING AND SCULPTURE** p. 68
 - Electroplated bits for marble engraving
 - Conical
 - Cylindrical
 - Rounded
 - Bas-relief conical bit in PCD for granite
 - Bas-relief conical bit in tungsten carbide for soft marble
- Bas-relief conical bit in tungsten carbide for hard marble
 - Bas-relief conical bit in tungsten carbide two sharps for marble
 - Bas-relief conical bit in tungsten carbide spiral shape for marble
- **TOOLS FOR BEVEL** p. 70
 - Cup wheels diameter 150 mm hole 22 mm V0 (INTERMAC)
 - Cup wheels diameter 150 mm hole 22 mm V3 (INTERMAC)
 - Cup wheels diameter 150 mm hole 22 mm V7 (INTERMAC)

INDEX

- **TOOLS FOR SINK WORKING** p. 71
 For granite with block stone connection ISO40
 For granite with 1/2" GAS connection
 For marble - electroplated diamond heads
 Flange extensions ISO40 for marble electroplated diamond heads
 Flange extensions ISO40 for marble electroplated diamond heads NIPLOY processing anticorrosion
- **TOOLS FOR SURFACE POLISHING WITH CNC MACHINES** p. 72
 Diameter 250 mm for flat surfaces granite and engineered stone
 Diameter 150 mm for inclined surfaces max extension 150 mm granite and engineered stone p. 73
- **TOOLS FOR ANTIQUE FINISHING** p. 74
 Brushes for surface antique finishing diameter 130 mm
 Brushes for surface antique finishing diameter 100 mm
 Brushes for edge antique finishing diameter 150 mm
- **TOOLS FOR INTERNAL SINK HOLE POLISHING WITH AGGREGATE ON CNC** p. 75
 For Intermac aggregate granite and engineered stone
- **DIAMOND TOOLS FOR EDGE POLISHER MACHINES** p. 76
 Diamond wheels typology available on catalogue
 COMANDULLI
 MONTRESOR
 SASSO MECCANICA
 BRETON
 PARK INDUSTRIES
- **RESIN POLISHING WHEELS FOR EDGE POLISHER MACHINES** p. 79
 Diameter 130 mm - Snail Lock @ - Flat Edge - Granite and Engineered Stone
 Diameter 130 mm - Left Snail Lock @ - Flat Edge - Granite and Engineered Stone
 Diameter 130 mm - Snail Lock @ - Bull Nose - Granite and Engineered Stone
 Diameter 130 mm - Left Snail Lock @ - Bull Nose - Granite and Engineered Stone
 Diameter 150 mm - Snail Lock @ - Eccentric wheel - Flat Edge - Granite and Engineered Stone
 Diameter 150 mm - Left Snail Lock @ - Eccentric wheel - Flat Edge - Granite and Engineered Stone
 Diameter 150 mm - Snail Lock @ - Eccentric wheel - Bull Nose - Granite and Engineered Stone
 Diameter 150 mm - Left Snail Lock @ - Eccentric wheel - Bull Nose - Granite and Engineered Stone
 Grit size suggested sequences for flat edge
- **BLADES FOR DRY CUTTING** p. 82
 Granite with perforated body Model D
 Granite with lateral reinforcement Model DR
 Granite curved blades
 Marble Electroplated
 Gres with central reinforcement
 Turbo cup wheel with Aluminium body

INDEX

- **BLADES FOR INTERMAC CNC**

- Diameter 180 mm for shaped cut
- Diameter 200 mm
- Diameter 250 mm
- Diameter 350 mm
- Diameter 500 mm
- Diameter 625 mm
- Diameter 230 mm for cut 44 degrees
- Diameter 150 mm for RODDING cut

p. 83

TECHNICAL INFORMATION

Diamond grits table

FEPA	U.S Mesh	DIAMUT	Mesh Size
D427	40/50	B	50
D301	50/60	C	60
D252	60/80	E	80
D181	80/100	F	100
D151	100/120	G	120
D126	120/140	H	140
D107	140/170	I	170
D91	170/200	L	200
D76	200/230	M	230
D64	230/270	N	270
D54	270/325	Z	325
D46	325/400	P	400
D39	400/500	Q	500
D33	500/600	R	600

Micron	U.S Mesh	DIAMUT
40/60 μ	600	R
30/40 μ	800	S
22/36 μ	1000	T

Diamond wheels description

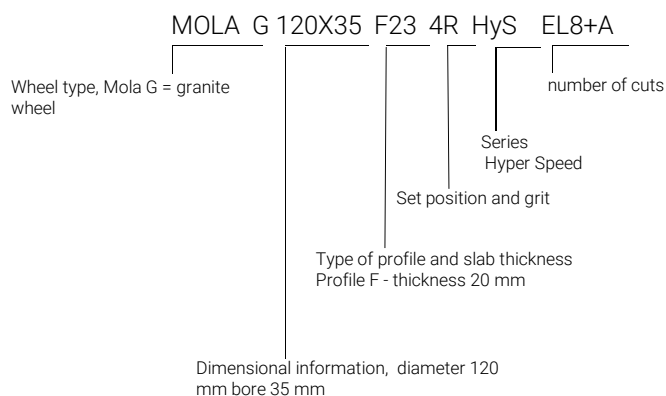

Dimensional information

A	Hole for internal cooling
D	Diameter
EL (n°)	Cuts on diamond ring
EL (n°)+A	Cuts with hole for internal cooling
H	Bore Diameter
HC	Bore with sline
J	Hub Diameter
R	Radius
S	Angle of the body wheel
T	Total thickness of the wheel body
T1	Reduced hub thickness
U	Thickness of the shape
U1	Flat section of the shape (for trap.wheels)
V	Angle
W	Width of diamond ring
X	Diamond Thickness
P	Depth of edge (for pencil edge wheels)
L	Total Length
L1	Working length
L2	Length of the diamond section
Z	Number of segments
Y	Shaft diameter

NOTE: All dimensions present in this price list are in mm

DRILLS

SEGMENTED DRILLS FOR GRANITE/MARBLE

Diameter	L	L1	Code	Price
18	104	50	D6782	€ -
20	104	50	D6783	€ -
22	104	50	D6827	€ -
25	104	50	D6761	€ -
30	104	50	D6743	€ -
35	104	50	D6722	€ -
40	104	50	D6767	€ -
45	104	50	D6786	€ -
50	104	50	D6684	€ -
55	104	50	D6787	€ -
70	104	50	D6790	€ -



CONTINUOUS RIM DRILLS FOR GRANITE/MARBLE

Diameter	L	L1	Code	Price
6	95	50	DOFGR000006	€ -
8	95	50	DOFGR000008	€ -
10	95	50	DOFGR000010	€ -
12	95	50	DOFGR000012	€ -
14	95	50	DOFGR000014	€ -
15	95	50	DOFGR000015	€ -
16	95	50	DOFGR000016	€ -
18	95	50	DOFGR000018	€ -
20	95	50	DOFGR000020	€ -
22	95	50	DOFGR000022	€ -
25	95	50	DOFGR000025	€ -
28	95	50	DOFGR000028	€ -
30	95	50	DOFGR000030	€ -
32	95	50	DOFGR000032	€ -
35	95	50	DOFGR000035	€ -
38	95	50	DOFGR000038	€ -
40	95	50	DOFGR000040	€ -
42	95	50	DOFGR000042	€ -
45	95	50	DOFGR000045	€ -
50	95	50	DOFGR000050	€ -
55	95	50	DOFGR000055	€ -
60	95	50	DOFGR000060	€ -
65	95	50	DOFGR000065	€ -
68	95	50	DOFGR000068	€ -
70	95	50	DOFGR000070	€ -
80	95	50	DOFGR000080	€ -
90	95	50	DOFGR000090	€ -
100	95	50	DOFGR000100	€ -



DRILLS

DEAD HOLE DRILLS FOR GRANITE L1-55

Diameter	L	L1	Code	Price
5	105	55	D6665	€ -
6	105	55	D6647	€ -
7	105	55	D6724	€ -
8	105	55	D6531	€ -
10	105	55	D6533	€ -
11	105	55	D6528	€ -
12	105	55	D6532	€ -
14	105	55	D6529	€ -
15	105	55	D6875	€ -
20	105	55	D6699	€ -



DEAD HOLE DRILLS FOR GRANITE L1-40

Diameter	L	L1	Code	Price
6	90	40	D6933	€ -
8	90	40	D6930	€ -
10	90	40	D6932	€ -
12	90	40	D6931	€ -
15	90	40	D6951	€ -



ROUTERS AND STEP CUT BIT

APPLICATION CHART

Type	Engineered stone (ENG)	Hard Granites (HGR)	Soft granites (SGR)	Marble
BLACK STORM 	✓	✓		
GOLD - LONG LIFE 	✓	✓		
GREEN 		✓		
BLUE 	✓	✓	✓	
ELECTROPLATED 				✓

BLACK STORM

Diameter	H	Z	Code	Price
22	35	7	DFR02265	€ -
22	45	7	DFR02266	€ -

GOLD - LONG LIFE

Diameter	H	Z	Code	Price
20	40	5	DFR01887	€ -
20	45	5	DFR01920	€ -
22	35	5	DFR02149	€ -

GREEN

Diameter	H	Z	Code	Price
20	40	5	DFR00982	€ -
20	45	5	DFR01100	€ -
22	35	5	DFR02215	€ -
22	45	5	DFR02264	€ -

BLUE

Diameter	H	Z	Code	Price
22	35	5	DFR02517	€ -
22	45	5	DFR02518	€ -

ROUTERS AND STEP CUT BIT

ELECTROPLATED

Diameter	H	Code	Price
6	23	DFFR00646	€ -
8	23	DFFR00647	€ -
10	23	DFFR00639	€ -
12	23	DFFR00652	€ -
16	25	DFFR00697	€ -
16	35	DFFR00621	€ -
16	45	DFFR00622	€ -
20	50	DFFR00640	€ -
20	60	DFFR00620	€ -
22	80	DFFR00708	€ -
25	80	DFFR00641	€ -
25	110	DFFR00011	€ -

Note: Diameter 6 to 12 appropriate to inlayed work

GRANITE ROUTERS DIAMETER 24 MM

Diameter	H	Z	Code	Price
24	25	5	DFR06747	€ -
24	35	5	DFR00669	€ -
24	45	5	DFR07022	€ -
24	60	5	DFR00265	€ -
24	70	5	DFR00198	€ -



VACUM BRAZED ROUTERS FOR MARBLE AND STONE

Diameter	H	Code	Price
16	45	DFFR90046	€ -
16	55	DFFR90227	€ -
18	45	DFFR90642	€ -



STEP CUT BIT

Diameter	Working length	Wheel fitting	Material	Code	Price
20	20	M12	Granito/Granite - Marmo/Marble	DPT01D	-
25	18	M14	Granito/Granite - Marmo/Marble	DPT03	-
25	18	M14	Pietre abrasive - Abrasive Stones	DPT08	-
20	10	M12	Marmo - Marble	DPT05	-
20	20	M12	Marmo - Marble	DPT06	-



BIT HOLDER 1/2" GAS FOR STEP CUT BIT

Holder Diameter 18 mm

Total Length	Working length	Wheel fitting	Code	Price
75	40	M12	D12109	€ -
99	66	M12	D9631	€ -
153	120	M12	D9632	€ -
183	150	M12	D9769	€ -
100	65	M14	D9562	€ -
153	120	M14	D9432	€ -



Holder Diameter 23 mm

Total Length	Working length	Wheel fitting	Code	Price
143	100	M14	D10009	€ -
173	130	M14	D9772	€ -
210	253	M14	D9837	€ -

ROUTERS AND STEP CUT BIT

HOLDERS FOR BLOCK STONE CONE ISO40 FOR STEP CUT BIT

Holder Diameter 23 mm

Total Length	Working length	Wheel fitting	Code	Price
171	150	M14	D10612	€ -
191	170	M14	D10365	€ -



ELECTROPLATED ROUTERS FOR MARBLE WITH CHANGEABLE HEAD

Body router with electroplated diamond 1/2"GAS connection

Diameter	H	Working length	Wheel fitting	R	Code	Price
20	40	110	M12	-	DFFR90264	-
25	90	90	M14	-	DFFR90131	-

Changeable head

Diameter	H	Working length	Wheel fitting	R	Code	Price
20	20	20	M12	3	DFFR90265	-
20	20	20	M12	9	DFFR90245	-
25	20	20	M14	3	DFFR90133	-
25	30	30	M14	3	DFFR90342	-

LEFT DRILLS (SX)

Continuous rim drills for Granite/Marble

Diameter	L	L1	Code	Price
10	95	50	DOFGR000010SX	€ -
12	95	50	DOFGR000012SX	€ -
14	95	50	DOFGR000014SX	€ -
15	95	50	DOFGR000015SX	€ -
16	95	50	DOFGR000016SX	€ -
18	95	50	DOFGR000018SX	€ -
20	95	50	DOFGR000020SX	€ -
22	95	50	DOFGR000022SX	€ -
25	95	50	DOFGR000025SX	€ -
28	95	50	DOFGR000028SX	€ -
30	95	50	DOFGR000030SX	€ -
32	95	50	DOFGR000032SX	€ -
35	95	50	DOFGR000035SX	€ -
38	95	50	DOFGR000038SX	€ -
40	95	50	DOFGR000040SX	€ -
42	95	50	DOFGR000042SX	€ -
45	95	50	DOFGR000045SX	€ -
50	95	50	DOFGR000050SX	€ -



LEFT ROUTERS AND LEFT STEP CUT BIT

STEP CUT BIT

Diameter	Working length	Arris	Material	Code	Price
20	20	M12	Granit - Marbre	DPT127	€ -
25	15	M14	Granit - Marbre	DPT135	€ -
30	15	M14	Granit - Marbre	DPT134	€ -
16	11	M10 SX	Dekton	DPT136K	€ -



BIT HOLDER 1/2" GAS FOR STEP CUT BIT

Holder Diameter 18 mm

Total Length	Working length	Arris	Code	Price
75	40	M12	D12829	€ -
99	66	M12	D10463	€ -
99	66	M12	D12830	€ - INOX

Holder Diameter 23 mm

Total Length	Working length	Arris	Code	Price
143	100	M14	D12865	€ -



LEFT ROUTERS AND LEFT STEP CUT BIT

Black storm

Diameter	H	Z	Code	Price
22	45	7	DFR02266SX	€ -

Gold - Long Life

Diameter	H	Z	Code	Price
20	45	5	DFR01920SX	€ -

Green

Diameter	H	Z	Code	Price

All the prices are in: EURO

20	40	5	DFR00982SX	€	-	
20	45	5	DFR01100SX	€	-	
20	40	5+1	DFR01310SX	€	-	DIAMOND IN THE HEAD

Blue

Diameter	H	Z	Code	Price
22	45	5	DFR02518SX	€ -

LEFT ROUTERS AND LEFT STEP CUT BIT

ELECTROPLATED

Diameter	H	Code	Price
16	35	DFFR00621SX	€ -
16	45	DFFR00622SX	€ -
20	50	DFFR00640SX	€ -
20	60	DFFR00620SX	€ -

CALIBRATING WHEELS

POWER EDGE HYPER SPEED LINE FOR GRANITE AND ENGINEERED STONE

Standard segment

Pos.	Diameter	H	Slab thickness	Code	Price
1	80	35	30 mm	DGH82469	€ -
2	80	35		DGH82261	€ -
1	80	35	40 mm	DGH82580	€ -
2	80	35		DGH82581	€ -

HYS²
HYPER SPEED SOLUTION



Arrow segment

Pos.	Diameter	H	Slab thickness	Code	Price
1	80	35	30 mm	DGH83271	€ -
2	80	35		DGH83272	€ -
1	80	35	40 mm	DGH83273	€ -
2	80	35		DGH83274	€ -

HYS²
HYPER SPEED SOLUTION



CORNER BREAKERS

SEGMENTED CORNER BREAKER PROFILE X

Hyper speed line for granite and engineered stone

Diameter	H	Slab thickness	Code	Price
120	35	Up to 40 mm	DGH77010	€ -
120	35	Up to 60 mm	DGH75838	€ -



SEGMENTED CORNER BREAKER PROFILE Y

Hyper speed line for granite and engineered stone

Diameter	H	Slab thickness	Code	Price
120	35	20 mm	DGH75232	€ -
120	35	30 mm	DGH72079	€ -







WHEELS FOR EDGE PROFILING

DIAMOND AND POLISHING WHEELS RANGE FOR GRANITE AND ENGINEERED STONE



Diamond wheels hyper speed line for granite and engineered stone



 Pos.1	<p>Hyper speed line for granite and engineered stone</p>
 Pos.2	<ul style="list-style-type: none"> • New generation metal bond, higher number of slots for internal cooling Grinding and cuts for internal cooling processed by EDM technology
 Pos.3	<ul style="list-style-type: none"> • Sequence composed by 4 diamond wheels pos. 1B - 2H - 3N - 4R The 5S available on request
 Pos.4	<ul style="list-style-type: none"> • Availables on diameter 120 - 80 - 60 - 40 mm request customized profiles <p style="text-align: right;">On</p>

WHEELS FOR EDGE PROFILING

FLASH polishing rubber wheels for granite, marble and engineered stone

 <p>Pos.5</p>	<ul style="list-style-type: none">• One set for granite, marble, engineered stone
 <p>Pos.6</p>	<ul style="list-style-type: none">• For all CNC machines
 <p>Pos.7</p>	<ul style="list-style-type: none">• Sequence of 3 polishing wheels p.5 (blue) - p.6 (gray) - p.7 (black) Standard small diameter 60 mm















Grinding service















- DIAMUT diamond wheels can be regrinded to optimize his life and quality
- DIAMUT supply regrinding wheels service

WHEELS DIAMETER 120 MM BORE 35 MM

AVAILABLE SHAPES ON CATALOGUE

Slab	Shape	Shape Specifics
	A	A23 R10 A33 R6 A33 R10 A33 R15 A43 R20
	AFR	AFR33 R15 R3
	AK31	AK31 32
	B	B23 R20 B33 R30
	BFR	BFR33 R30
	E	E33 B8 E33 B11,5 E33 B16
	EFR	EFR33 B11,5 R4
	F	F23 R12 F33 R17,4
	FB	FB43
	FBR	FBR33 R10 R3
	FV	FV33 FV43
	FZ	FZ36 R10 FZ43 R10
	FZR01	FZR01 33
	G	G23 G43

WHEELS DIAMETER 120 MM BORE 35 MM

Slab	Shape	Shape Specifics
	GV	GV43
	H	H23 H36
	L	L33
	O	O33
	Q	Q33
	SK07	SK0733
	T	T23 R3 T23 R6 T33 R3 T32 R6 T33 R8 T43 R3
	TK43	TK43 33
	TK57	TK57 33
	TP	TP33
	V	V23 V33 V43
	X	X20 18x25 X30 26x33 X40 36x43
	Z	Z22 Z33 Z43

WHEELS DIAMETER 120 MM BORE 35 MM

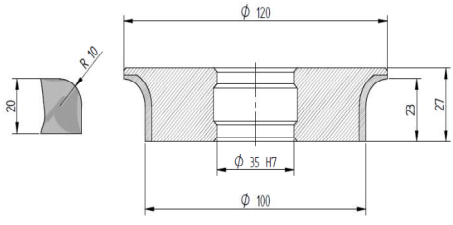
Shape A23 R10	2	Pos.	Type	MIN Ø	MAX Ø	Code	Price
	1	Segmented Diamond	100	120	DGH74070	€ -	
	2	Rough Diamond			DGH70882	€ -	
	3	Medium Diamond			DGH70883	€ -	
	4	Fine Diamond			DGH70884	€ -	
	5	Flash Blue	60	79	DLG60280	€ -	
	6	Flash Gray			DLG60281	€ -	
	7	Flash Black			DLG60282	€ -	
	Set price						€ -
5S		Fine 5S Diamond	100	120	DGH70687	€ -	

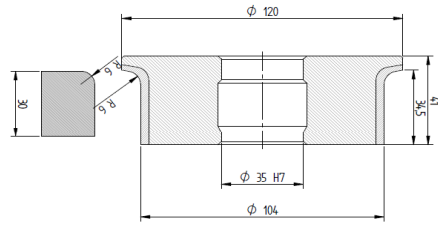
Shape A33 R6	3	Pos.	Type	MIN Ø	MAX Ø	Code	Price
	1	Segmented Diamond	104	120	DGH72388	€ -	
	2	Rough Diamond			DGH72389	€ -	
	3	Medium Diamond			DGH72390	€ -	
	4	Fine Diamond			DGH72391	€ -	
	5	Flash Blue	60	69	DLG60682	€ -	
	6	Flash Gray			DLG60683	€ -	
	7	Flash Black			DLG60684	€ -	
	Set price						€ -
5S		Fine 5S Diamond	104	120	DGH83321	€ -	

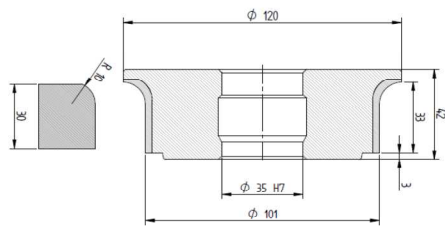
Shape A33 R10	3	Pos.	Type	MIN Ø	MAX Ø	Code	Price
	1	Segmented Diamond	101	120	DGH70544	€ -	
	2	Rough Diamond			DGH71930	€ -	
	3	Medium Diamond			DGH71931	€ -	
	4	Fine Diamond			DGH71932	€ -	
	5	Flash Blue	60	79	DLG60655	€ -	
	6	Flash Gray			DLG60656	€ -	
	7	Flash Black			DLG60657	€ -	
	Set price						€ -
5S		Fine 5S Diamond	101	120	DGH70548	€ -	

WHEELS DIAMETER 120 MM BORE 35 MM

Shape A33 R15	3	Pos.	Type	MIN Ø	MAX Ø	Code	Price
	1	Segmented Diamond	92	120	DGH71516	€ -	
	2	Rough Diamond			DGH71517	€ -	
	3	Medium Diamond			DGH71518	€ -	
	4	Fine Diamond	DGH71519	€ -			
	5	Flash Blue	DLG60346	€ -			
	6	Flash Gray	DLG60347	€ -			
	7	Flash Black	DLG60348	€ -			
	Set price						€ -
5S	Fine 5S Diamond	92	120	DGH70009	€		

Shape A43 R20	4	Pos.	Type	MIN Ø	MAX Ø	Code	Price
	1	Segmented Diamond	82	120	DGH70010	€ -	
	2	Rough Diamond			DGH70778	€ -	
	3	Medium Diamond			DGH70779	€ -	
	4	Fine Diamond	DGH70885	€ -			
	5	Flash Blue	DLG60037	€ -			
	6	Flash Gray	DLG60038	€ -			
	7	Flash Black	DLG60039	€ -			
	Set price						€ -
5S	Fine 5S Diamond	82	120	---	€ #N/D		

Shape AFR33 R15 R3	3	Pos.	Type	MIN Ø	MAX Ø	Code	Price
	1	Segmented Diamond	89,6	120	DGH71516	€ -	
	2	Rough Diamond			DGH78789	€ -	
	3	Medium Diamond			DGH78790	€ -	
	4	Fine Diamond	DGH78791	€ -			
	5	Flash Blue	DLG60689	€ -			
	6	Flash Gray	DLG60690	€ -			
	7	Flash Black	DLG60691	€ -			
	Set price						€ -
5S	Fine 5S Diamond	89,6	120	DGH83258	€ -		

WHEELS DIAMETER 120 MM BORE 35 MM

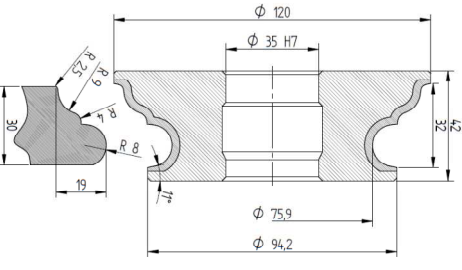
Shape AK31 32	3	Pos.	Type	MIN Ø	MAX Ø	Code	Price
	1	Segmented Diamond	75,9	120	DGH76558	€ -	
	2	Rough Diamond			DGH72172	€ -	
	3	Medium Diamond	DGH72173	€ -			
	4	Fine Diamond	DGH72174	€ -			
	5	Flash Blue	DLG60996	€ -			
	6	Flash Gray	DLG60997	€ -			
	7	Flash Black	DLG60998	€ -			
	Set price						€ -
5S	Fine 5S Diamond	75,9	120	---	€ #N/D		

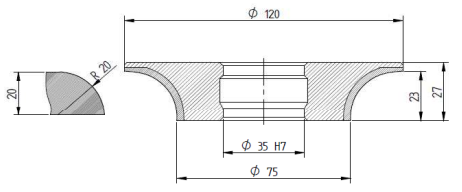
Shape B23 R20	2	Pos.	Type	MIN Ø	MAX Ø	Code	Price
	1	Segmented Diamond	75	120	DGH75408	€ -	
	2	Rough Diamond			DGH70835	€ -	
	3	Medium Diamond	DGH70836	€ -			
	4	Fine Diamond	DGH70837	€ -			
	5	Flash Blue	DLG60298	€ -			
	6	Flash Gray	DLG60299	€ -			
	7	Flash Black	DLG60300	€ -			
	Set price						€ -
5S	Fine 5S Diamond	75	120	DGH70623	€ -		

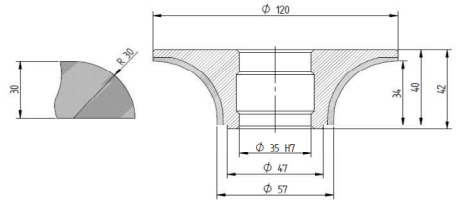
Shape B33 R30	3	Pos.	Type	MIN Ø	MAX Ø	Code	Price
	1	Segmented Diamond	57	120	DGH73703	€ -	
	2	Rough Diamond			DGH72730	€ -	
	3	Medium Diamond	DGH72731	€ -			
	4	Fine Diamond	DGH72732	€ -			
	5	Flash Blue	DLG60112	€ -			
	6	Flash Gray	DLG60113	€ -			
	7	Flash Black	DLG60114	€ -			
	Set price						€ -
5S	Fine 5S Diamond	57	120	DGH83275	€ -		

WHEELS DIAMETER 120 MM BORE 35 MM

Shape BFR33 R30	3	Pos.	Type	MIN Ø	MAX Ø	Code	Price
	1	Segmented Diamond	59	120	DGH73703	€ -	
	2	Rough Diamond			DGH79808	€ -	
	3	Medium Diamond			DGH79809	€ -	
	4	Fine Diamond			DGH79810	€ -	
	5	Flash Blue	60	120	DLG60358	€ -	
	6	Flash Gray			DLG60359	€ -	
	7	Flash Black			DLG60360	€ -	
	Set price						€ -
5S	Fine 5S Diamond	59	120	DGH83318	€ -		

Shape E33 B8	3	Pos.	Type	MIN Ø	MAX Ø	Code	Price
	1	Segmented Diamond	104	120	DGH77716	€ -	
	2	Rough Diamond			DGH77713	€ -	
	3	Medium Diamond			DGH77714	€ -	
	4	Fine Diamond			DGH77715	€ -	
	5	Flash Blue	60	76	DLG60241	€ -	
	6	Flash Gray			DLG60242	€ -	
	7	Flash Black			DLG60243	€ -	
	Set price						€ -
5S	Fine 5S Diamond	104	120	DGH83049	€ -		

Shape E33 B11,5	3	Pos.	Type	MIN Ø	MAX Ø	Code	Price
	1	Segmented Diamond	97	120	DGH77069	€ -	
	2	Rough Diamond			DGH73037	€ -	
	3	Medium Diamond			DGH73038	€ -	
	4	Fine Diamond			DGH73039	€ -	
	5	Flash Blue	60	113	DLG60121	€ #N/D	
	6	Flash Gray			DLG60122	€ #N/D	
	7	Flash Black			DLG60123	€ #N/D	
	Set price						€ #N/D
5S	Fine 5S Diamond	97	120	DGH83050	€ -		

WHEELS DIAMETER 120 MM BORE 35 MM

Shape E33 B16	3	Pos.	Type	MIN Ø	MAX Ø	Code	Price
	1	Segmented Diamond	88	120	DGH74487	€ -	
	2	Rough Diamond			DGH74488	€ -	
	3	Medium Diamond			DGH74489	€ -	
	4	Fine Diamond			DGH74490	€ -	
	5	Flash Blue	60	92	DLG60016	€ -	
	6	Flash Gray			DLG60017	€ -	
	7	Flash Black			DLG60018	€ -	
	Set price						€ -
5S	Fine 5S Diamond	88	120	---	€ #N/D		

Shape EFR33 B11,5 R4	3	Pos.	Type	MIN Ø	MAX Ø	Code	Price
	1	Segmented Diamond	100	120	DGH77069	€ -	
	2	Rough Diamond			DGH75392	€ -	
	3	Medium Diamond			DGH75393	€ -	
	4	Fine Diamond			DGH75394	€ -	
	5	Flash Blue	60	80	DLG60631	€ -	
	6	Flash Gray			DLG60632	€ -	
	7	Flash Black			DLG60633	€ -	
	Set price						€ -
5S	Fine 5S Diamond	100	120	DGH83190	€ -		

Shape F23 R12	2	Pos.	Type	MIN Ø	MAX Ø	Code	Price
	1	Segmented Diamond	73,5	120	DGH72898	€ -	
	2	Rough Diamond			DGH70767	€ -	
	3	Medium Diamond			DGH70768	€ -	
	4	Fine Diamond			DGH70777	€ -	
	5	Flash Blue	60	107	DLG60499	€ -	
	6	Flash Gray			DLG60500	€ -	
	7	Flash Black			DLG60501	€ -	
	Set price						€ -
5S	Fine 5S Diamond	73,5	120	DGH83569	€ -		

WHEELS DIAMETER 120 MM BORE 35 MM

Shape F33 R17,4	3	Pos.	Type	MIN Ø	MAX Ø	Code	Price
	1	Segmented Diamond	58	120	DGH70415	€ -	
	2	Rough Diamond			DGH70898	€ -	
	3	Medium Diamond			DGH70899	€ -	
	4	Fine Diamond			DGH70900	€ -	
	5	Flash Blue	60	122	DLG60019	€ -	
	6	Flash Gray			DLG60020	€ -	
	7	Flash Black			DLG60021	€ -	
	Set price						€ -
5S	Fine 5S Diamond	58	120	DGH70419	€ -		

Shape FB43	4	Pos.	Type	MIN Ø	MAX Ø	Code	Price
	1	Segmented Diamond	78	120	DGH73931	€ -	
	2	Rough Diamond			DGH73932	€ -	
	3	Medium Diamond			DGH73933	€ -	
	4	Fine Diamond			DGH73934	€ -	
	5	Flash Blue	60	102	DLG61066	€ -	
	6	Flash Gray			DLG61067	€ -	
	7	Flash Black			DLG61068	€ -	
	Set price						€ -
5S	Fine 5S Diamond	78	120	---	€ #N/D		

Shape FBR33 R10 R3	3	Pos.	Type	MIN Ø	MAX Ø	Code	Price
	1	Segmented Diamond	72	120	DGH80335	€ -	
	2	Rough Diamond			DGH80336	€ -	
	3	Medium Diamond			DGH80337	€ -	
	4	Fine Diamond			DGH80338	€ -	
	5	Flash Blue	60	108	DLG60634	€ -	
	6	Flash Gray			DLG60635	€ -	
	7	Flash Black			DLG60636	€ -	
	Set price						€ -
5S	Fine 5S Diamond	72	120	---	€ #N/D		

WHEELS DIAMETER 120 MM BORE 35 MM

Shape FV33	3	Pos.	Type	MIN Ø	MAX Ø	Code	Price
	1	Segmented Diamond	76,5	120	DGH75283	€ -	
	2	Rough Diamond			DGH76517	€ -	
	3	Medium Diamond			DGH76518	€ -	
	4	Fine Diamond	DGH76519	€ -			
	5	Flash Blue	DLG60172	60	104	DLG60172	€ -
	6	Flash Gray	DLG60173			€ -	
	7	Flash Black	DLG60174			€ -	
	Set price						€ -
5S	Fine 5S Diamond	76,5	120	---	€ #N/D		

Shape FV43	4	Pos.	Type	MIN Ø	MAX Ø	Code	Price
	1	Segmented Diamond	62	120	DGH73514	€ -	
	2	Rough Diamond			DGH73515	€ -	
	3	Medium Diamond			DGH73516	€ -	
	4	Fine Diamond	DGH73517	€ -			
	5	Flash Blue	DLG60725	60	118	DLG60725	€ -
	6	Flash Gray	DLG60726			€ -	
	7	Flash Black	DLG60727			€ -	
	Set price						€ -
5S	Fine 5S Diamond	62	120	---	€ #N/D		

Shape FZ36 R10	3	Pos.	Type	MIN Ø	MAX Ø	Code	Price
	1	Segmented Diamond	80	120	DGH78193	€ -	
	2	Rough Diamond			DGH74910	€ -	
	3	Medium Diamond			DGH74702	€ -	
	4	Fine Diamond	DGH74703	€ -			
	5	Flash Blue	DLG60247	60	100	DLG60247	€ -
	6	Flash Gray	DLG60248			€ -	
	7	Flash Black	DLG60249			€ -	
	Set price						€ -
5S	Fine 5S Diamond	80	120	DGH74704	€ -		

WHEELS DIAMETER 120 MM BORE 35 MM

Shape FZ43 R10	4	Pos.	Type	MIN Ø	MAX Ø	Code	Price
	1	Segmented Diamond	80	120	DGH78344	€ -	
	2	Rough Diamond			DGH75764	€ -	
	3	Medium Diamond			DGH75765	€ -	
	4	Fine Diamond			DGH75766	€ -	
	5	Flash Blue	60	100	DLG60277	€ -	
	6	Flash Gray			DLG60278	€ -	
	7	Flash Black			DLG60279	€ -	
	Set price						€ -
5S	Fine 5S Diamond	80	120	DGH83197	€ -		

Shape FZR01 33	3	Pos.	Type	MIN Ø	MAX Ø	Code	Price
	1	Segmented Diamond	74	120	DGH78193	€ -	
	2	Rough Diamond			DGH82343	€ -	
	3	Medium Diamond			DGH82344	€ -	
	4	Fine Diamond			DGH82345	€ -	
	5	Flash Blue	60	106	DLG60673	€ -	
	6	Flash Gray			DLG60674	€ -	
	7	Flash Black			DLG60675	€ -	
	Set price						€ -
5S	Fine 5S Diamond	74	120	DGH83317	€ -		

Shape G23	2	Pos.	Type	MIN Ø	MAX Ø	Code	Price
	1	Segmented Diamond	81	120	DGH76277	€ -	
	2	Rough Diamond			DGH70844	€ -	
	3	Medium Diamond			DGH70845	€ -	
	4	Fine Diamond			DGH70846	€ -	
	5	Flash Blue	60	99	DLG60352	€ -	
	6	Flash Gray			DLG60353	€ -	
	7	Flash Black			DLG60354	€ -	
	Set price						€ -
5S	Fine 5S Diamond	81	120	--	€ #N/D		

WHEELS DIAMETER 120 MM BORE 35 MM

Shape G33	3	Pos.	Type	MIN Ø	MAX Ø	Code	Price
	1	Segmented Diamond	68	120	DGH74690	€ -	
	2	Rough Diamond			DGH71242	€ -	
	3	Medium Diamond	DGH71243	€ -			
	4	Fine Diamond	DGH71244	€ -			
	5	Flash Blue	DLG60000	€ -			
	6	Flash Gray	DLG60001	€ -			
	7	Flash Black	DLG60002	€ -			
	Set price						€ -
5S	Fine 5S Diamond	68	120	DGH83192	€ -		

Shape G43	4	Pos.	Type	MIN Ø	MAX Ø	Code	Price
	1	Segmented Diamond	52	120	DGH74719	€ -	
	2	Rough Diamond			DGH71589	€ -	
	3	Medium Diamond	DGH71590	€ -			
	4	Fine Diamond	DGH71591	€ -			
	5	Flash Blue	DLG60355	€ -			
	6	Flash Gray	DLG60356	€ -			
	7	Flash Black	DLG60357	€ -			
	Set price						€ -
5S	Fine 5S Diamond	52	120	---	€ #N/D		

Shape GV43	4	Pos.	Type	MIN Ø	MAX Ø	Code	Price
	1	Segmented Diamond	80	120	DGH73293	€ -	
	2	Rough Diamond			DGH73294	€ -	
	3	Medium Diamond	DGH71431	€ -			
	4	Fine Diamond	DGH71432	€ -			
	5	Flash Blue	DLG60160	€ -			
	6	Flash Gray	DLG60161	€ -			
	7	Flash Black	DLG60162	€ -			
	Set price						€ -
5S	Fine 5S Diamond	80	120	---	€ #N/D		

WHEELS DIAMETER 120 MM BORE 35 MM

Shape H23	2	Pos.	Type	MIN Ø	MAX Ø	Code	Price
	1	Segmented Diamond	80	120	DGH70090	€ -	
	2	Rough Diamond			DGH71344	€ -	
	3	Medium Diamond			DGH71345	€ -	
	4	Fine Diamond			DGH71346	€ -	
	5	Flash Blue	60	100	DLG61018	€ -	
	6	Flash Gray			DLG61019	€ -	
	7	Flash Black			DLG61020	€ -	
	Set price						€ -
5S		Fine 5S Diamond	80	120	---	€ #N/D	

Shape H36	3	Pos.	Type	MIN Ø	MAX Ø	Code	Price
	1	Segmented Diamond	74	120	DGH72618	€ -	
	2	Rough Diamond			DGH71790	€ -	
	3	Medium Diamond			DGH71791	€ -	
	4	Fine Diamond			DGH71792	€ -	
	5	Flash Blue	60	106	DLG60244	€ -	
	6	Flash Gray			DLG60245	€ -	
	7	Flash Black			DLG60246	€ -	
	Set price						€ -
5S		Fine 5S Diamond	74	120	---	€ #N/D	

Shape L33	3	Pos.	Type	MIN Ø	MAX Ø	Code	Price
	1	Segmented Diamond	72	120	DGH72867	€ -	
	2	Rough Diamond			DGH72868	€ -	
	3	Medium Diamond			DGH72869	€ -	
	4	Fine Diamond			DGH72870	€ -	
	5	Flash Blue	60	108	DLG60740	€ -	
	6	Flash Gray			DLG60741	€ -	
	7	Flash Black			DLG60742	€ -	
	Set price						€ -
5S		Fine 5S Diamond	72	120	---	€ #N/D	

WHEELS DIAMETER 120 MM BORE 35 MM

Shape O33	3	Pos.	Type	MIN Ø	MAX Ø	Code	Price
	1	Segmented Diamond	70	120	DGH70120	€ -	
	2	Rough Diamond			DGH71234	€ -	
	3	Medium Diamond			DGH71235	€ -	
	4	Fine Diamond			DGH71236	€ -	
	5	Flash Blue	60	110	DLG61039	€ -	
	6	Flash Gray			DLG61040	€ -	
	7	Flash Black			DLG61041	€ -	
	Set price						€ -
5S		Fine 5S Diamond	70	120	DGH70124	€ -	

Shape Q33	3	Pos.	Type	MIN Ø	MAX Ø	Code	Price
	1	Segmented Diamond	66	120	DGH75496	€ -	
	2	Rough Diamond			DGH70871	€ -	
	3	Medium Diamond			DGH70872	€ -	
	4	Fine Diamond			DGH70873	€ -	
	5	Flash Blue	60	114	DLG60211	€ -	
	6	Flash Gray			DLG60212	€ -	
	7	Flash Black			DLG60213	€ -	
	Set price						€ -
5S		Fine 5S Diamond	66	120	DGH70139	€ -	

Shape SK0733	3	Pos.	Type	MIN Ø	MAX Ø	Code	Price
	1	Segmented Diamond	69	120	DGH72829	€ -	
	2	Rough Diamond			DGH72024	€ -	
	3	Medium Diamond			DGH72025	€ -	
	4	Fine Diamond			DGH72026	€ -	
	5	Flash Blue	60	111	DLG60514	€ -	
	6	Flash Gray			DLG60515	€ -	
	7	Flash Black			DLG60516	€ -	
	Set price						€ -
5S		Fine 5S Diamond	69	120	---	€ #N/D	

WHEELS DIAMETER 120 MM BORE 35 MM

Shape T23 R3	2	Pos.	Type	MIN Ø	MAX Ø	Code	Price
	1	Segmented Diamond	113	120	DGH72707	€ -	
	2	Rough Diamond			DGH70859	€ -	
	3	Medium Diamond			DGH70860	€ -	
	4	Fine Diamond			DGH70861	€ -	
	5	Flash Blue	60	67	DLG60006	€ -	
	6	Flash Gray			DLG60007	€ -	
	7	Flash Black			DLG60008	€ -	
	Set price						€ -
5S		Fine 5S Diamond	113	120	DGH83241	€ -	

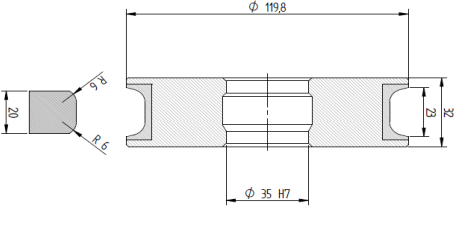
Shape T23 R6	2	Pos.	Type	MIN Ø	MAX Ø	Code	Price
	1	Segmented Diamond	108	120	DGH81052	€ -	
	2	Rough Diamond			DGH81053	€ -	
	3	Medium Diamond			DGH81054	€ -	
	4	Fine Diamond			DGH81055	€ -	
	5	Flash Blue	60	72	DLG61142	€ -	
	6	Flash Gray			DLG61143	€ -	
	7	Flash Black			DLG61144	€ -	
	Set price						€ -
5S		Fine 5S Diamond	108	120	DGH83336	€ -	

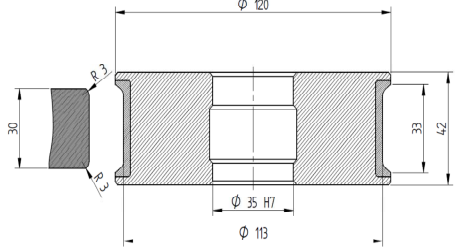
Shape T33 R3	3	Pos.	Type	MIN Ø	MAX Ø	Code	Price
	1	Segmented Diamond	113	120	DGH70255	€ -	
	2	Rough Diamond			DGH71199	€ -	
	3	Medium Diamond			DGH71200	€ -	
	4	Fine Diamond			DGH71201	€ -	
	5	Flash Blue	60	67	DLG60133	€ -	
	6	Flash Gray			DLG60134	€ -	
	7	Flash Black			DLG60135	€ -	
	Set price						€ -
5S		Fine 5S Diamond	113	120	DGH70154	€ -	

WHEELS DIAMETER 120 MM BORE 35 MM

Shape T32 R6	3	Pos.	Type	MIN Ø	MAX Ø	Code	Price		
	1	Segmented Diamond	104	120	DGH74548	€ -			
	2	Rough Diamond			DGH74549	€ -			
	3	Medium Diamond			DGH74550	€ -			
	4	Fine Diamond	DGH74551	€ -					
	5	Flash Blue	DLG60646	60	76	DLG60647	€ -		
	6	Flash Gray	DLG60647			€ -			
	7	Flash Black	DLG60648			€ -			
	Set price						€ -		
5S Fine 5S Diamond						104	120	DGH83041	€ -

Shape T33 R8	3	Pos.	Type	MIN Ø	MAX Ø	Code	Price		
	1	Segmented Diamond	103	120	DGH70577	€ -			
	2	Rough Diamond			DGH74529	€ -			
	3	Medium Diamond			DGH74530	€ -			
	4	Fine Diamond	DGH74531	€ -					
	5	Flash Blue	DLG60250	60	77	DLG60251	€ -		
	6	Flash Gray	DLG60251			€ -			
	7	Flash Black	DLG60252			€ -			
	Set price						€ -		
5S Fine 5S Diamond						103	120	DGH83292	€ -

Shape T43 R3	4	Pos.	Type	MIN Ø	MAX Ø	Code	Price		
	1	Segmented Diamond	113	120	DGH70496	€ -			
	2	Rough Diamond			DGH71543	€ -			
	3	Medium Diamond			DGH71544	€ -			
	4	Fine Diamond	DGH71545	€ -					
	5	Flash Blue	DLG60313	60	67	DLG60314	€ -		
	6	Flash Gray	DLG60314			€ -			
	7	Flash Black	DLG60315			€ -			
	Set price						€ -		
5S Fine 5S Diamond						113	120	DGH70159	€ -

WHEELS DIAMETER 120 MM BORE 35 MM

Shape TK43 33	3	Pos.	Type	MIN Ø	MAX Ø	Code	Price						
	1	Segmented Diamond	70	120	DGH82202	€ -							
	2	Rough Diamond			DGH82452	€ -							
	3	Medium Diamond			DGH82453	€ -							
	4	Fine Diamond			DGH82454	€ -							
	5	Flash Blue	60	110	DLG60667	€ -							
	6	Flash Gray			DLG60668	€ -							
	7	Flash Black			DLG60669	€ -							
	Set price						€ -						
<table border="1"> <tr> <td>5S</td> <td>Fine 5S Diamond</td> <td>70</td> <td>120</td> <td>DGH83319</td> <td>€ -</td> </tr> </table>								5S	Fine 5S Diamond	70	120	DGH83319	€ -
5S	Fine 5S Diamond	70	120	DGH83319	€ -								

Shape TK57 33	3	Pos.	Type	MIN Ø	MAX Ø	Code	Price						
	1	Segmented Diamond	56	120	DGH78993	€ -							
	2	Rough Diamond			DGH78994	€ -							
	3	Medium Diamond			DGH78995	€ -							
	4	Fine Diamond			DGH78996	€ -							
	5	Flash Blue	56	120	DLG61693	€ -							
	6	Flash Gray			DLG61694	€ -							
	7	Flash Black			DLG61695	€ -							
	Set price						€ -						
<table border="1"> <tr> <td>5S</td> <td>Fine 5S Diamond</td> <td>56</td> <td>120</td> <td>---</td> <td>€ #N/D</td> </tr> </table>								5S	Fine 5S Diamond	56	120	---	€ #N/D
5S	Fine 5S Diamond	56	120	---	€ #N/D								

Shape TP33	3	Pos.	Type	MIN Ø	MAX Ø	Code	Price						
	1	Segmented Diamond	60	120	DGH74729	€ -							
	2	Rough Diamond			DGH71138	€ -							
	3	Medium Diamond			DGH71139	€ -							
	4	Fine Diamond			DGH71140	€ -							
	5	Flash Blue	60	120	DLG60028	€ -							
	6	Flash Gray			DLG60029	€ -							
	7	Flash Black			DLG60030	€ -							
	Set price						€ -						
<table border="1"> <tr> <td>5S</td> <td>Fine 5S Diamond</td> <td>60</td> <td>120</td> <td>DGH70169</td> <td>€ -</td> </tr> </table>								5S	Fine 5S Diamond	60	120	DGH70169	€ -
5S	Fine 5S Diamond	60	120	DGH70169	€ -								

Shape V22	2	Pos.	Type	MIN Ø	MAX Ø	Code	Price						
	1	Segmented Diamond	96	120	DGH70190	€ -							
	2	Rough Diamond			DGH70853	€ -							
	3	Medium Diamond			DGH70854	€ -							
	4	Fine Diamond			DGH70855	€ -							
	5	Flash Blue	60	84	DLG60340	€ -							
	6	Flash Gray			DLG60341	€ -							
	7	Flash Black			DLG60342	€ -							
	Set price						€ -						
<table border="1"> <tr> <td>5S</td> <td>Fine 5S Diamond</td> <td>96</td> <td>120</td> <td>---</td> <td>€ #N/D</td> </tr> </table>								5S	Fine 5S Diamond	96	120	---	€ #N/D
5S	Fine 5S Diamond	96	120	---	€ #N/D								

WHEELS DIAMETER 120 MM BORE 35 MM

Shape V33	3	Pos.	Type	MIN Ø	MAX Ø	Code	Price
	1	Segmented Diamond	86	120	DGH74661	€ -	
	2	Rough Diamond			DGH72151	€ -	
	3	Medium Diamond			DGH72152	€ -	
	4	Fine Diamond			DGH72153	€ -	
	5	Flash Blue	60	94	DLG60031	€ -	
	6	Flash Gray			DLG60032	€ -	
	7	Flash Black			DLG60033	€ -	
	Set price						€ -
5S	Fine 5S Diamond	86	120	DGH83257	€ -		

Shape V43	4	Pos.	Type	MIN Ø	MAX Ø	Code	Price
	1	Segmented Diamond	75	120	DGH75407	€ -	
	2	Rough Diamond			DGH72319	€ -	
	3	Medium Diamond			DGH72320	€ -	
	4	Fine Diamond			DGH72321	€ -	
	5	Flash Blue	60	105	DLG60040	€ -	
	6	Flash Gray			DLG60041	€ -	
	7	Flash Black			DLG60042	€ -	
	Set price						€ -
5S	Fine 5S Diamond	75	120	DGH70204	€ -		

Shape X20 18x25	2	Pos.	Type	MIN Ø	MAX Ø	Code	Price
	1	Segmented Diamond	113	120	DGH72707	€ -	
	2	Rough Diamond			DGH76972	€ -	
	3	Medium Diamond			DGH76973	€ -	
	4	Fine Diamond			DGH76974	€ -	
	5	Flash Blue	60	67	DLG60142	€ -	
	6	Flash Gray			DLG60143	€ -	
	7	Flash Black			DLG60144	€ -	
	Set price						€ -
5S	Fine 5S Diamond	113	120	DGH83458	€ -		

WHEELS DIAMETER 120 MM BORE 35 MM

Shape X30 26x33	3	Pos.	Type	MIN Ø	MAX Ø	Code	Price
	1	Segmented Diamond	114	120	DGH70255	€ -	
	2	Rough Diamond			DGH77859	€ -	
	3	Medium Diamond			DGH77860	€ -	
	4	Fine Diamond			DGH77861	€ -	
	5	Flash Blue	60	66	DLG60145	€ -	
	6	Flash Gray			DLG60146	€ -	
	7	Flash Black			DLG60147	€ -	
	Set price						€ -
5S	Fine 5S Diamond	114	120	DGH83460	€ -		

Shape X40 36x43	4	Pos.	Type	MIN Ø	MAX Ø	Code	Price
	1	Segmented Diamond	111	120	DGH70496	€ -	
	2	Rough Diamond			DGH79717	€ -	
	3	Medium Diamond			DGH79718	€ -	
	4	Fine Diamond			DGH79719	€ -	
	5	Flash Blue	60	69	DLG60148	€ -	
	6	Flash Gray			DLG60149	€ -	
	7	Flash Black			DLG60150	€ -	
	Set price						€ -
5S	Fine 5S Diamond	111	120	DGH83722	€ -		

Shape Z22	2	Pos.	Type	MIN Ø	MAX Ø	Code	Price
	1	Segmented Diamond	120	120	DGH72707	€ -	
	2	Rough Diamond			DGH71202	€ -	
	3	Medium Diamond			DGH71203	€ -	
	4	Fine Diamond			DGH71204	€ -	
	5	Flash Blue	60	60	DLG61220	€ -	
	6	Flash Gray			DLG61221	€ -	
	7	Flash Black			DLG61222	€ -	
	Set price						€ -
5S	Fine 5S Diamond	120	120	--	€ #N/D		



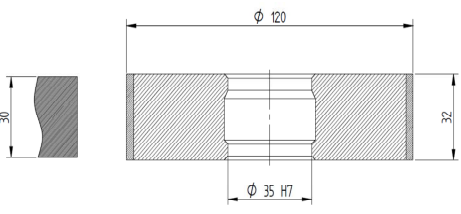

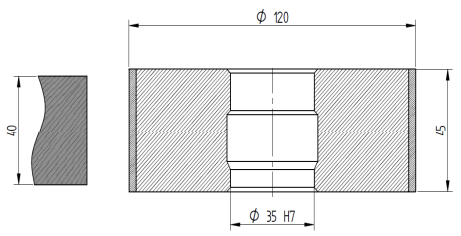



WHEELS DIAMETER 120 MM BORE 35 MM

Shape Z33	3	Pos.	Type	MIN Ø	MAX Ø	Code	Price
	1	Segmented Diamond	120	120	DGH70255	€ -	
	2	Rough Diamond			DGH70972	€ -	
	3	Medium Diamond			DGH70973	€ -	
	4	Fine Diamond			DGH70974	€ -	
	5	Flash Blue	70	70	DLG60433	€ -	
	6	Flash Gray			DLG60434	€ -	
	7	Flash Black			DLG60435	€ -	
	Set price						€ -
5S	Fine 5S Diamond	120	120	DGH70259	€ -		

Shape Z43	4	Pos.	Type	MIN Ø	MAX Ø	Code	Price
	1	Segmented Diamond	120	120	DGH70496	€ -	
	2	Rough Diamond			DGH71463	€ -	
	3	Medium Diamond			DGH71464	€ -	
	4	Fine Diamond			DGH71465	€ -	
	5	Flash Blue	80	80	DLG60097	€ -	
	6	Flash Gray			DLG60098	€ -	
	7	Flash Black			DLG60099	€ -	
	Set price						€ -
5S	Fine 5S Diamond	120	120	---	€ #N/D		

WHEELS DIAMETER 80 MM BORE 35 MM

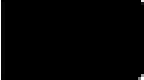
AVAILABLE SHAPES ON CATALOGUE

Slab	Shape	Shape Specifics
	A	A23 R10 A33 R6 A33 R10 A35 R15 A43 R6
	AFR	AFR33 R6 R3
	AK2	AK2 33 R30 AK2 43 R40
	AK2R	AK2R 33 R30 R55
	E	E23 B8 E33 B8 h.25 E33 B11,5 E43 B8 E43 B11,5
	SK19	SK19 33
	T	T23 R3 T23 R6 T33 R3 T32 R6 T43 R3
	X	X20 18x25 X30 26x33
	Z	Z22 Z33 Z45

WHEELS DIAMETER 80 MM BORE 35 MM

Shape	A23 R10	2	Pos.	Type	MIN Ø	MAX Ø	Code	Price
	1	Segmented Diamond	60	80	DGH74440	€	-	
	2	Rough Diamond			DGH74082	€	-	
	3	Medium Diamond			DGH74083	€	-	
	4	Fine Diamond			DGH74084	€	-	
	5	Flash Blue	60	80	DLG60280	€	-	
	6	Flash Gray			DLG60281	€	-	
	7	Flash Black			DLG60282	€	-	
	Set price							€
5S		Fine 5S Diamond	60	80	DGH83337	€	-	

Shape	A33 R6	3	Pos.	Type	MIN Ø	MAX Ø	Code	Price
	1	Segmented Diamond	64	80	DGH72878	€	-	
	2	Rough Diamond			DGH72879	€	-	
	3	Medium Diamond			DGH72880	€	-	
	4	Fine Diamond			DGH72881	€	-	
	5	Flash Blue	60	76	DLG60682	€	-	
	6	Flash Gray			DLG60683	€	-	
	7	Flash Black			DLG60684	€	-	
	Set price							€
5S		Fine 5S Diamond	64	80	DGH83043	€	-	

Shape	A33 R10	3	Pos.	Type	MIN Ø	MAX Ø	Code	Price
	1	Segmented Diamond	61	80	DGH82037	€	-	
	2	Rough Diamond			DGH75504	€	-	
	3	Medium Diamond			DGH75504	€	-	
	4	Fine Diamond			DGH75506	€	-	
	5	Flash Blue	60	79	DLG60655	€	-	
	6	Flash Gray			DLG60656	€	-	
	7	Flash Black			DLG60657	€	-	
	Set price							€
5S		Fine 5S Diamond	61	80	---	€	#N/D	

WHEELS DIAMETER 80 MM BORE 35 MM

Shape A35 R15	3	Pos.	Type	MIN Ø	MAX Ø	Code	Price
	1	Segmented Diamond	52	80	DGH77977	€ -	
	2	Rough Diamond			DGH72692	€ -	
	3	Medium Diamond			DGH72693	€ -	
	4	Fine Diamond			DGH72694	€ -	
	5	Flash Blue	52	80	DLG60346	€ -	
	6	Flash Gray			DLG60347	€ -	
	7	Flash Black			DLG60348	€ -	
	Set price						€ -
5S	Fine 5S Diamond	52	80	DGH83242	€ -		

Shape A43 R6	4	Pos.	Type	MIN Ø	MAX Ø	Code	Price
	1	Segmented Diamond	64	80	DGH81145	€ -	
	2	Rough Diamond			DGH81146	€ -	
	3	Medium Diamond			DGH81147	€ -	
	4	Fine Diamond			DGH81148	€ -	
	5	Flash Blue	60	76	DLG60034	€ -	
	6	Flash Gray			DLG60035	€ -	
	7	Flash Black			DLG60036	€ -	
	Set price						€ -
5S	Fine 5S Diamond	64	80	---	€ #N/D		

Shape AFR33 R6 R3	3	Pos.	Type	MIN Ø	MAX Ø	Code	Price
	1	Segmented Diamond	64	80	DGH72878	€ -	
	2	Rough Diamond			DGH77020	€ -	
	3	Medium Diamond			DGH77021	€ -	
	4	Fine Diamond			DGH77022	€ -	
	5	Flash Blue	60	76	DLG60685	€ -	
	6	Flash Gray			DLG60686	€ -	
	7	Flash Black			DLG60687	€ -	
	Set price						€ -
5S	Fine 5S Diamond	64	80	DGH83238	€ -		

WHEELS DIAMETER 80 MM BORE 35 MM

Shape AK2 33 R30	3	Pos.	Type	MIN Ø	MAX Ø	Code	Price
	1	Segmented Diamond	70	80	DGH77079	€ -	
	2	Rough Diamond			DGH77080	€ -	
	3	Medium Diamond			DGH77081	€ -	
	4	Fine Diamond			DGH77082	€ -	
	5	Flash Blue	60	70	DLG60658	€ -	
	6	Flash Gray			DLG60659	€ -	
	7	Flash Black			DLG60660	€ -	
	Set price						€ -
5S		Fine 5S Diamond	70	80	DGH83320	€ -	

Shape AK2R 33 R30 R5	3	Pos.	Type	MIN Ø	MAX Ø	Code	Price
	1	Segmented Diamond	63	80	DGH76525	€ -	
	2	Rough Diamond			DGH76526	€ -	
	3	Medium Diamond			DGH76527	€ -	
	4	Fine Diamond			DGH76528	€ -	
	5	Flash Blue	60	77	DLG61324	€ -	
	6	Flash Gray			DLG61325	€ -	
	7	Flash Black			DLG61326	€ -	
	Set price						€ -
5S		Fine 5S Diamond	63	80	DGH83721	€ -	

Shape AK2 43 R40	4	Pos.	Type	MIN Ø	MAX Ø	Code	Price
	1	Segmented Diamond	67	80	DGH77083	€ -	
	2	Rough Diamond			DGH77084	€ -	
	3	Medium Diamond			DGH77085	€ -	
	4	Fine Diamond			DGH77086	€ -	
	5	Flash Blue	60	73	DLG60809	€ -	
	6	Flash Gray			DLG60810	€ -	
	7	Flash Black			DLG60811	€ -	
	Set price						€ -
5S		Fine 5S Diamond	67	80	---	€ #N/D	

WHEELS DIAMETER 80 MM BORE 35 MM

Shape E23 B8	2	Pos.	Type	MIN Ø	MAX Ø	Code	Price
	1	Segmented Diamond	64	80	DGH82304	€ -	
	2	Rough Diamond			DGH82305	€ -	
	3	Medium Diamond			DGH82306	€ -	
	4	Fine Diamond			DGH82307	€ -	
	5	Flash Blue	60	76	DLG60803	€ -	
	6	Flash Gray			DLG60804	€ -	
	7	Flash Black			DLG60805	€ -	
	Set price						€ -
5S		Fine 5S Diamond	64	80	---	€ #N/D	

Shape E33 B8 h.25	3	Pos.	Type	MIN Ø	MAX Ø	Code	Price
	1	Segmented Diamond	64	80	DGH76258	€ -	
	2	Rough Diamond			DGH74226	€ -	
	3	Medium Diamond			DGH74187	€ -	
	4	Fine Diamond			DGH74188	€ -	
	5	Flash Blue	60	76	DLG60241	€ -	
	6	Flash Gray			DLG60242	€ -	
	7	Flash Black			DLG60243	€ -	
	Set price						€ -
5S		Fine 5S Diamond	64	80	DGH83237	€ -	

Shape E33 B11,5	3	Pos.	Type	MIN Ø	MAX Ø	Code	Price
	1	Segmented Diamond	57	80	DGH75827	€ -	
	2	Rough Diamond			DGH75828	€ -	
	3	Medium Diamond			DGH75829	€ -	
	4	Fine Diamond			DGH75830	€ -	
	5	Flash Blue	60	83	DLG60121	€ #N/D	
	6	Flash Gray			DLG60122	€ #N/D	
	7	Flash Black			DLG60123	€ #N/D	
	Set price						€ #N/D
5S		Fine 5S Diamond	57	80	---	€ #N/D	

WHEELS DIAMETER 80 MM BORE 35 MM

Shape E43 B8	4	Pos.	Type	MIN Ø	MAX Ø	Code	Price
	1	Segmented Diamond	64	80	DGH76392	€ -	
	2	Rough Diamond			DGH76393	€ -	
	3	Medium Diamond			DGH76394	€ -	
	4	Fine Diamond			DGH76395	€ -	
	5	Flash Blue	60	76	DLG60839	€ -	
	6	Flash Gray			DLG60840	€ -	
	7	Flash Black			DLG60841	€ -	
	Set price						€ -
5S	Fine 5S Diamond	64	80	DGH83360	€ -		

Shape E43 B11,5	4	Pos.	Type	MIN Ø	MAX Ø	Code	Price
	1	Segmented Diamond	57	80	DGH75524	€ -	
	2	Rough Diamond			DGH75525	€ -	
	3	Medium Diamond			DGH75526	€ -	
	4	Fine Diamond			DGH75527	€ -	
	5	Flash Blue	60	83	DLG60670	€ -	
	6	Flash Gray			DLG60671	€ -	
	7	Flash Black			DLG60672	€ -	
	Set price						€ -
5S	Fine 5S Diamond	57	80	---	€ #N/D		

Shape SK19 33	3	Pos.	Type	MIN Ø	MAX Ø	Code	Price
	1	Segmented Diamond	70	80	DGH78113	€ -	
	2	Rough Diamond			DGH78114	€ -	
	3	Medium Diamond			DGH78115	€ -	
	4	Fine Diamond			DGH78116	€ -	
	5	Flash Blue	60	70	DLG60520	€ -	
	6	Flash Gray			DLG60521	€ -	
	7	Flash Black			DLG60522	€ -	
	Set price						€ -
5S	Fine 5S Diamond	70	80	---	€ #N/D		

WHEELS DIAMETER 80 MM BORE 35 MM

Shape T23 R3	2	Pos.	Type	MIN Ø	MAX Ø	Code	Price
	1	Segmented Diamond	73	80	DGH74430	€ -	
	2	Rough Diamond			DGH74431	€ -	
	3	Medium Diamond			DGH74432	€ -	
	4	Fine Diamond			DGH74433	€ -	
	5	Flash Blue	60	67	DLG60006	€ -	
	6	Flash Gray			DLG60007	€ -	
	7	Flash Black			DLG60008	€ -	
	Set price						€ -
5S	Fine 5S Diamond	73	80	DGH79518	€ -		

Shape T23 R6	2	Pos.	Type	MIN Ø	MAX Ø	Code	Price
	1	Segmented Diamond	68	80	DGH81056	€ -	
	2	Rough Diamond			DGH81057	€ -	
	3	Medium Diamond			DGH81058	€ -	
	4	Fine Diamond			DGH81059	€ -	
	5	Flash Blue	60	72	DLG61142	€ -	
	6	Flash Gray			DLG61143	€ -	
	7	Flash Black			DLG61144	€ -	
	Set price						€ -
5S	Fine 5S Diamond	68	80	---	€ #N/D		

Shape T33 R3	3	Pos.	Type	MIN Ø	MAX Ø	Code	Price
	1	Segmented Diamond	73	80	DGH71189	€ -	
	2	Rough Diamond			DGH72808	€ -	
	3	Medium Diamond			DGH72809	€ -	
	4	Fine Diamond			DGH72810	€ -	
	5	Flash Blue	60	72	DLG60133	€ -	
	6	Flash Gray			DLG60134	€ -	
	7	Flash Black			DLG60135	€ -	
	Set price						€ -
5S	Fine 5S Diamond	73	80	DGH78167	€ -		

WHEELS DIAMETER 80 MM BORE 35 MM

Shape T32 R6	3	Pos.	Type	MIN Ø	MAX Ø	Code	Price
	1	Segmented Diamond	64	80	DGH74008	€ -	
	2	Rough Diamond			DGH74009	€ -	
	3	Medium Diamond			DGH74010	€ -	
	4	Fine Diamond			DGH74011	€ -	
	5	Flash Blue	60	76	DLG60646	€ -	
	6	Flash Gray			DLG60647	€ -	
	7	Flash Black			DLG60648	€ -	
	Set price						€ -
5S	Fine 5S Diamond	64	80	DGH83044	€ -		

Shape T43 R3	4	Pos.	Type	MIN Ø	MAX Ø	Code	Price
	1	Segmented Diamond	74	80	DGH72597	€ -	
	2	Rough Diamond			DGH71697	€ -	
	3	Medium Diamond			DGH71698	€ -	
	4	Fine Diamond			DGH71699	€ -	
	5	Flash Blue	60	66	DLG60313	€ -	
	6	Flash Gray			DLG60314	€ -	
	7	Flash Black			DLG60315	€ -	
	Set price						€ -
5S	Fine 5S Diamond	74	80	DGH83398	€ -		

Shape X20 18x25	2	Pos.	Type	MIN Ø	MAX Ø	Code	Price
	1	Segmented Diamond	74	80	DGH74430	€ -	
	2	Rough Diamond			DGH81414	€ -	
	3	Medium Diamond			DGH81415	€ -	
	4	Fine Diamond			DGH81416	€ -	
	5	Flash Blue	60	66	DLG60142	€ -	
	6	Flash Gray			DLG60143	€ -	
	7	Flash Black			DLG60144	€ -	
	Set price						€ -
5S	Fine 5S Diamond	74	80	---	€ #N/D		

WHEELS DIAMETER 80 MM BORE 35 MM

Shape X30 26x33	3	Pos.	Type	MIN Ø	MAX Ø	Code	Price
	1	Segmented Diamond	73	80	DGH71189	€ -	
	2	Rough Diamond			DGH77756	€ -	
	3	Medium Diamond			DGH77757	€ -	
	4	Fine Diamond			DGH77758	€ -	
	5	Flash Blue	60	77	DLG60145	€ -	
	6	Flash Gray			DLG60146	€ -	
	7	Flash Black			DLG60147	€ -	
	Set price						€ -
5S	Fine 5S Diamond	73	80	DGH83046	€ -		

Shape Z22	2	Pos.	Type	MIN Ø	MAX Ø	Code	Price
	1	Segmented Diamond	80	80	DGH74430	€ -	
	2	Rough Diamond			DGH74302	€ -	
	3	Medium Diamond			DGH74303	€ -	
	4	Fine Diamond			DGH74304	€ -	
	5	Flash Blue	60	60	DLG61220	€ -	
	6	Flash Gray			DLG61221	€ -	
	7	Flash Black			DLG61222	€ -	
	Set price						€ -
5S	Fine 5S Diamond	80	80	DGH74311	€ -		



Shape Z33	3	Pos.	Type	MIN Ø	MAX Ø	Code	Price
	1	Segmented Diamond	80	80	DGH71189	€ -	
	2	Rough Diamond			DGH72804	€ -	
	3	Medium Diamond			DGH72805	€ -	
	4	Fine Diamond			DGH72806	€ -	
	5	Flash Blue	60	60	DLG60478	€ -	
	6	Flash Gray			DLG60479	€ -	
	7	Flash Black			DLG60480	€ -	
	Set price						€ -
5S	Fine 5S Diamond	80	80	DGH82651	€ -		

WHEELS DIAMETER 80 MM BORE 35 MM

Shape Z45	4	Pos.	Type	MIN Ø	MAX Ø	Code	Price
	1	Segmented Diamond	80	80	DGH72597	€ -	
	2	Rough Diamond			DGH71466	€ -	
	3	Medium Diamond			DGH71467	€ -	
	4	Fine Diamond			DGH71468	€ -	
	5	Flash Blue	60	60	DLG60322	€ -	
	6	Flash Gray			DLG60323	€ -	
	7	Flash Black			DLG60324	€ -	
	Set price						€ -
5S	Fine 5S Diamond	80	80	DGH83045	€ -		

WHEELS FOR INNER SINK HOLE BORE 22 MM

AVAILABLE SHAPES ON CATALOGUE

Slab	Shape	Shape Specifics
	A	A23 R6 A33 R6 A43 R6
	T	T23 R3 T33 R3
	Z	Z45

WHEELS FOR INNER SINK HOLE BORE 22 MM

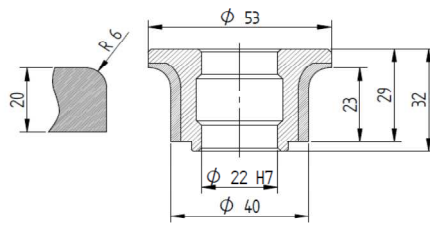
Shape A23 R6	3	Pos.	Type	Code	Price
	1		Rough Diamond	DGH77807	€ -
	2		Rough Diamond	DGH78371	€ -
	3		Medium Diamond	DGH78372	€ -
	4		Fine Diamond	DGH78373	€ -
	5		Flash Blue	DLG60815	€ -
	6		Flash Gray	DLG60816	€ -
	7		Flash Black	DLG60817	€ -
	Set price				
5S		Fine 5S Diamond	---	€ #N/D	

Note: FLASH polishing wheels with inner diameter 40 mm

Note: Pos.1 Continuous Band, not segmented

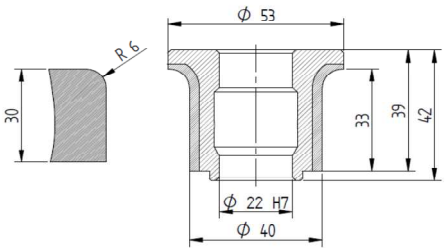
Shape A33 R6	3	Pos.	Type	Code	Price
	1		Rough Diamond	DGH78384	€ -
	2		Rough Diamond	DGH74183	€ -
	3		Medium Diamond	DGH74184	€ -
	4		Fine Diamond	DGH74185	€ -
	5		Flash Blue	DLG60818	€ -
	6		Flash Gray	DLG60819	€ -
	7		Flash Black	DLG60820	€ -
	Set price				
5S		Fine 5S Diamond	DGH74998	€ -	

Note: FLASH polishing wheels with inner diameter 40 mm

Note: Pos.1 Continuous Band, not segmented

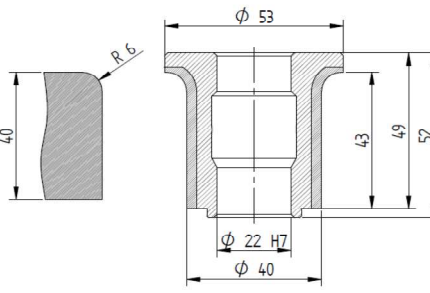
Shape A43 R6	3	Pos.	Type	Code	Price
	1		Rough Diamond	DGH82458	€ -
	2		Rough Diamond	DGH82459	€ -
	3		Medium Diamond	DGH82460	€ -
	4		Fine Diamond	DGH82461	€ -
	5		Flash Blue	DLG60821	€ -
	6		Flash Gray	DLG60822	€ -
	7		Flash Black	DLG60823	€ -
	Set price				
5S		Fine 5S Diamond	---	€ #N/D	

Note: FLASH polishing wheels with inner diameter 40 mm

Note: Pos.1 Continuous Band, not segmented

WHEELS FOR INNER SINK HOLE BORE 22 MM

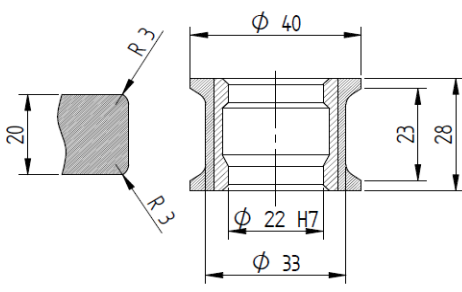
Shape T23 R3	3	Pos.	Type	Code	Price
	1	Segmented Diamond	DGH73204	€ -	
	2	Rough Diamond	DGH73205	€ -	
	3	Medium Diamond	DGH73206	€ -	
	4	Fine Diamond	DGH73207	€ -	
	5	Flash Blue	DLG61154	€ -	
	6	Flash Gray	DLG61155	€ -	
	7	Flash Black	DLG61156	€ -	
	Set price				€ -
5S	Fine 5S Diamond	DGH83240	€ -		

Note: FLASH polishing wheels with inner diameter 40 mm

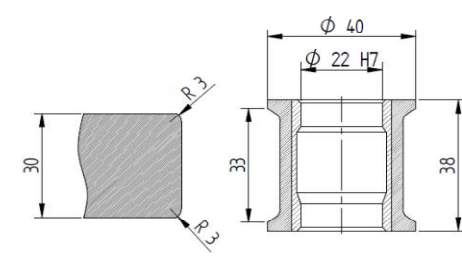
Shape T33 R3	2	Pos.	Type	Code	Price
	1	Segmented Diamond	DGH70810	€ -	
	2	Rough Diamond	DGH72297	€ -	
	3	Medium Diamond	DGH72298	€ -	
	4	Fine Diamond	DGH72299	€ -	
	5	Flash Blue	DLG61157	€ -	
	6	Flash Gray	DLG61158	€ -	
	7	Flash Black	DLG61159	€ -	
	Set price				€ -
5S	Fine 5S Diamond	DGH83191	€ -		

Note: FLASH polishing wheels with inner diameter 40 mm

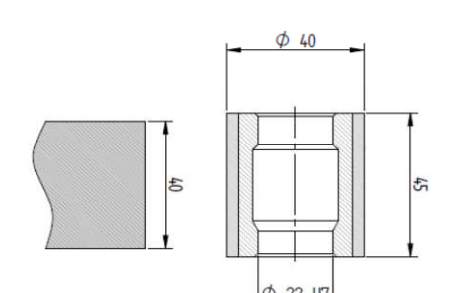
Shape Z45	3	Pos.	Type	Code	Price
	1	Segmented Diamond	DGH72004	€ -	
	2	Rough Diamond	DGH72137	€ -	
	3	Medium Diamond	DGH72138	€ -	
	4	Fine Diamond	DGH72139	€ -	
	5	Flash Blue	DLG61111	€ -	
	6	Flash Gray	DLG61112	€ -	
	7	Flash Black	DLG61113	€ -	
	Set price				€ -
5S	Fine 5S Diamond	DGH71967	€ -		

Note: FLASH polishing wheels with inner diameter 40 mm

WHEELS FOR INNER SINK HOLE 1/2" GAS CONNECTION

AVAILABLE SHAPES ON CATALOGUE

Slab	Shape	Shape Specifics
	A	A36 R5 Lower side A36 R5 Upper side
	E	E36 B8 Sotto E36 B8 Upper side
	T	T23 R3 T33 R3 T32 R6
	X	X20 18x22 X30 26x33 X30 23x33
	Z	Z45

TOOLS SEQUENCE



WHEELS FOR INNER SINK HOLE 1/2"GAS CONNECTION

Shape A36R5	Lower side	3	Pos.	Type	Code	Price
		1	Segmented Diamond	DGH79394	€	#N/D
	2	Rough Diamond	DGH79395	€	#N/D	
	3	Medium Diamond	DGH79396	€	#N/D	
	4	Fine Diamond	DGH80243	€	#N/D	
	5	Flash Blue	DLG30115	€	-	
	6	Flash Gray	DLG30116	€	-	
	7	Flash Black	DLG30117	€	-	
	Set price					
5S	Fine 5S Diamond	DGH83987	€	#N/D		

Shape A36R5	Upper side	3	Pos.	Type	Code	Price
		1	Segmented Diamond	DGH79993	€	-
	2	Rough Diamond	DGH79994	€	-	
	3	Medium Diamond	DGH79995	€	-	
	4	Fine Diamond	DGH79996	€	-	
	5	Flash Blue	DLG30304	€	-	
	6	Flash Gray	DLG30305	€	-	
	7	Flash Black	DLG30306	€	-	
	Set price					
5S	Fine 5S Diamond	DGH83988	€	#N/D		

Shape E36B8	Sotto	3	Pos.	Type	Code	Price
		1	Segmented Diamond	DGH80033	€	#N/D
	2	Rough Diamond	DGH80126	€	#N/D	
	3	Medium Diamond	DGH80127	€	#N/D	
	4	Fine Diamond	DGH80128	€	#N/D	
	5	Flash Blue	DLG31093	€	-	
	6	Flash Gray	DLG31094	€	-	
	7	Flash Black	DLG31095	€	-	
	Set price					
5S	Fine 5S Diamond	DGH83989	€	#N/D		

WHEELS FOR INNER SINK HOLE 1/2" GAS CONNECTION

Shape E36B8	Upper side	3	Pos.	Type	Code	Price
			1	Segmented Diamond	DGH79997	€ -
			2	Rough Diamond	DGH79998	€ #N/D
			3	Medium Diamond	DGH79999	€ #N/D
			4	Fine Diamond	DGH80378	€ #N/D
			5	Flash Blue	DLG31096	€ -
			6	Flash Gray	DLG31097	€ -
			7	Flash Black	DLG31098	€ -
			Set price			
			5S	Fine 5S Diamond	DGH83990	€ #N/D

Shape T23R3		2	Pos.	Type	Code	Price
			1	Segmented Diamond	DGH75373	€ -
			2	Rough Diamond	DGH80297	€ #N/D
			3	Medium Diamond	DGH80298	€ #N/D
			4	Fine Diamond	DGH80299	€ #N/D
			5	Flash Blue	DLG30106	€ -
			6	Flash Gray	DLG30107	€ -
			7	Flash Black	DLG30108	€ -
			Set price			
			5S	Fine 5S Diamond	DGH83991	€ #N/D

Shape T33 R3		3	Pos.	Type		
			1	Segmented Diamond	DGH75373	€ -
			2	Rough Diamond	DGH77531	€ #N/D
			3	Medium Diamond	DGH77532	€ #N/D
			4	Fine Diamond	DGH75459	€ #N/D
			5	Flash Blue	DLG30103	€ -
			6	Flash Gray	DLG30104	€ -
			7	Flash Black	DLG30105	€ -
			Set price			
			5S	Fine 5S Diamond	DGH83992	€ #N/D

WHEELS FOR INNER SINK HOLE 1/2" GAS CONNECTION

Shape T32 R6	3	Pos.	Type	Code	Price
	1	Segmented Diamond	DGH83313	€	#N/D
	2	Rough Diamond	DGH83314	€	#N/D
	3	Medium Diamond	DGH83315	€	#N/D
	4	Fine Diamond	DGH83316	€	#N/D
	5	Flash Blue	DLG31315	€	-
	6	Flash Gray	DLG31316	€	-
	7	Flash Black	DLG31317	€	-
	Set price				
5S	Fine 5S Diamond	DGH83997	€	-	

Shape X20 18X22	2	Pos.	Type	Code	Price
	1	Segmented Diamond	DGH81512	€	#N/D
	2	Rough Diamond	DGH81513	€	#N/D
	3	Medium Diamond	DGH81514	€	#N/D
	4	Fine Diamond	DGH81515	€	#N/D
	5	Flash Blue	DLG30382	€	-
	6	Flash Gray	DLG30383	€	-
	7	Flash Black	DLG30384	€	-
	Set price				
5S	Fine 5S Diamond	DGH83993	€	#N/D	

Shape X30 26X33	3	Pos.	Type	Code	Price
	1	Segmented Diamond	DGH75373	€	-
	2	Rough Diamond	DGH80519	€	#N/D
	3	Medium Diamond	DGH80520	€	#N/D
	4	Fine Diamond	DGH80521	€	#N/D
	5	Flash Blue	DLG30595	€	-
	6	Flash Gray	DLG30596	€	-
	7	Flash Black	DLG30597	€	-
	Set price				
5S	Fine 5S Diamond	DGH83996	€	#N/D	

WHEELS FOR INNER SINK HOLE 1/2"GAS CONNECTION

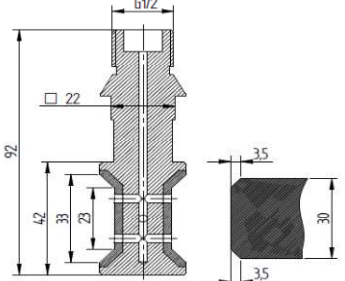
Shape X30 23X33	3	Pos.	Type	Code	Price	
	1	Segmented Diamond	DGH82929	€	-	
	2	Rough Diamond	DGH82930	€	-	
	3	Medium Diamond	DGH82931	€	-	
	4	Fine Diamond	DGH82932	€	-	
	5	Flash Blue	DLG30941	€	-	
	6	Flash Gray	DLG30942	€	-	
	7	Flash Black	DLG30943	€	-	
	Set price					€
5S	Fine 5S Diamond	DGH83994	€	#N/D		

Shape Z45	3-4	Pos.	Type	Code	Price	
	1	Segmented Diamond	DGH75373	€	-	
	2	Rough Diamond	DGH75374	€	-	
	3	Medium Diamond	DGH75375	€	-	
	4	Fine Diamond	DGH75376	€	-	
	5	Flash Blue	DLG30292	€	-	
	6	Flash Gray	DLG30293	€	-	
	7	Flash Black	DLG30294	€	-	
	Set price					€
5S	Fine 5S Diamond	DGH83995	€	#N/D		

PERIPHERAL WHEELS FOR MARBLE

ELECTROPLATED AND POLISHING WHEELS RANGE FOR MARBLE

Electroplated wheels

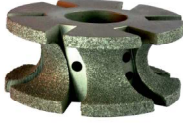
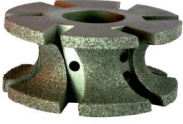
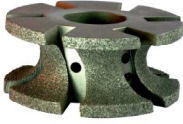
 <p>Pos.1</p>	<ul style="list-style-type: none"> • Mole elettrodeposte specifiche per applicazione molatura marmo
 <p>Pos.2</p>	<ul style="list-style-type: none"> • Sequenza dedicata composta da tre posizioni 1C - 2I - 3P
 <p>Pos.3</p>	<ul style="list-style-type: none"> • Available in diameter 120 mm bore 35 mm





Abrasive polishing wheel

 <p>Pos.4</p>	<ul style="list-style-type: none"> • Specific for marble, polish in only one step
--	--

High Quality Set			
 <p>Pos.3</p>	 <p>Pos.4</p>	 <p>Pos.5</p>	 <p>Pos.6</p>

PERIPHERAL WHEELS FOR MARBLE

AVAILABLE SHAPES ON CATALOGUE

Slab	Shape	Shape Specifics
	A	A33 R15
	B	B23 R20 B33 R30
	F	F33
	T	T23 R3
	V	V22

PERIPHERAL WHEELS FOR MARBLE

Shape A33 R15	120x35	3	Pos.	Type	Code	Price
	1	Electroplated	DM00300	€	-	
	2	Electroplated	DM00301	€	-	
	3	Electroplated	DM01158	€	-	
	4	Abrasive	DLG10236	€	-	
	Set price				€	-
High Quality Set						
	1	Electroplated	DM00300	€	-	
	2	Electroplated	DM00301	€	-	
	3	Fine Diamond	DGS71519	€	-	
	4	Flash Blue	DLG60346	€	-	
	5	Flash Gray	DLG60347	€	-	
	6	Flash Black	DLG60348	€	-	

Shape B23 R20	120x35	3	Pos.	Type	Code	Price
	1	Electroplated	DM00342	€	-	
	2	Electroplated	DM00343	€	-	
	3	Electroplated	DM01160	€	-	
	4	Abrasive	DLG10237	€	-	
	Set price				€	-
High Quality Set						
	1	Electroplated	DM00300	€	-	
	2	Electroplated	DM00301	€	-	
	3	Fine Diamond	DGS70837	€	-	
	4	Flash Blue	DLG60298	€	-	
	5	Flash Gray	DLG60299	€	-	
	6	Flash Black	DLG60300	€	-	

Shape B33 R30	120x35	3	Pos.	Type	Code	Price
	1	Electroplated	DM00286	€	-	
	2	Electroplated	DM00287	€	-	
	3	Electroplated	DM01161	€	-	
	4	Abrasive	DLG10150	€	-	
	Set price				€	-
High Quality Set						
	1	Electroplated	DM00300	€	-	
	2	Electroplated	DM00301	€	-	
	3	Fine Diamond	DGS72732	€	-	
	4	Flash Blue	DLG60112	€	-	
	5	Flash Gray	DLG60113	€	-	
	6	Flash Black	DLG60114	€	-	

PERIPHERAL WHEELS FOR MARBLE

Shape F33	120x35	3	Pos.	Type	Code	Price	
	1	Electroplated	DM00364	€	-		
	2	Electroplated	DM00365	€	-		
	3	Electroplated	DM01164	€	-		
	4	Abrasive	DLG10291	€	-		
	Set price				€		
	High Quality Set						
	1	Electroplated	DM00300	€	-		
	2	Electroplated	DM00301	€	-		
	3	Fine Diamond	DGS70900	€	-		
	4	Flash Blue	DLG60019	€	-		
5	Flash Gray	DLG60020	€	-			
6	Flash Black	DLG60021	€	-			

Shape T23 R3	120x35	2	Pos.	Type	Code	Price	
	1	Electroplated	DM00384	€	-		
	2	Electroplated	DM00385	€	-		
	3	Electroplated	DM01168	€	-		
	4	Abrasive	DLG10254	€	-		
	Set price				€		
	High Quality Set						
	1	Electroplated	DM00300	€	-		
	2	Electroplated	DM00301	€	-		
	3	Fine Diamond	DGS70861	€	-		
	4	Flash Blue	DLG60006	€	-		
5	Flash Gray	DLG60007	€	-			
6	Flash Black	DLG60008	€	-			

Shape V22	120x35	2	Pos.	Type	Code	Price	
	1	Electroplated	DM00402	€	-		
	2	Electroplated	DM00403	€	-		
	3	Electroplated	DM01172	€	-		
	4	Abrasive	DLG10259	€	-		
	Set price				€		
	High Quality Set						
	1	Electroplated	DM00300	€	-		
	2	Electroplated	DM00301	€	-		
	3	Fine Diamond	DGS70855	€	-		
	4	Flash Blue	DLG60340	€	-		
5	Flash Gray	DLG60341	€	-			
6	Flash Black	DLG60342	€	-			

CHAMFERING WHEELS

DIAMOND WHEELS FOR ARRIS

Diameter	Hole	Small diameter	Code	Price
120	35	102	DGH70572	€ #N/D
80	35	61	DGH70825	€ #N/D
80	22	61	DGH70570	€ #N/D
60	22	41	DGH74611	€ #N/D



Necessari 2 pezzi per codice / 2 pcs. For each code are needed

DISTANCE RINGS

Diameter	Hole	T	Code	Price
65	35	5	DD70018	€ -
65	35	7	DD70019	€ -
65	35	10	DD70031	€ -
50	35	7+10+10	DD70000	€ -
50	35	7	DD70013	€ -
50	35	10	DD70014	€ -
35	22	7+10+10	DD70002	€ -
35	22	7	DD70074	€ -
35	22	10	DD70075	€ -



ADAPTER FOR OPPOSITE MOUNTING

Working length	Wheel fitting	Machine cone connection	Code	Price
50	35	22	DD70043	€ -
85	35	22	DD70035	€ -
100	35	22	DD70045	€ -



Come funziona / how it works:

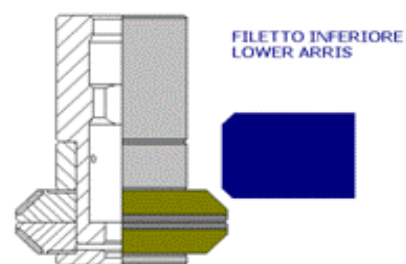
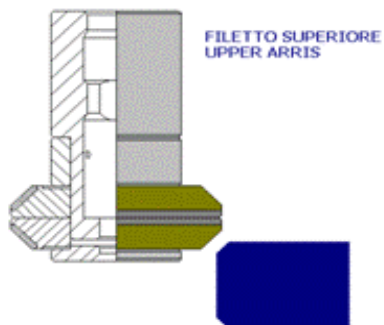

KITCHEN TOP

RECESS DRAIN WORKING PROCESS

Emptying



Chamfer and surface finishing



Chamfer polishing

Multipurpose (granite and engineered stone)

For granite only

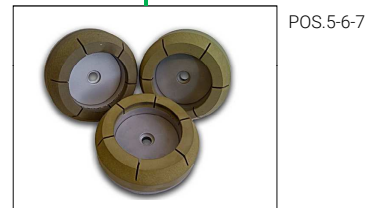

Surface polishing



Surface brightening (only granite)



KITCHEN TOP

MULTIPORPOSE SET FOR GRANITE, MARBLE AND ENGINEERED STONE WITH CHAMFER 60 DEGREES

Complete set with wheels supports included

Pos.	Type	Diameter	H	Grit	Code	Price
1	Breaking (stubbing wheel)	85	35	D301	DRI70162	€ -
2	Breaking (stubbing wheel)	85	35	D301	DRI70162	€ -
3	Chamfering and surface diam	120	35	D252	DRI70000	€ -
4	Chamfering and surface diam	120	35	D64	DRI70001	€ -
5	Resin for chamfer	110	22	500	DRI70594	€ -
6	Resin for chamfer	110	22	1000	DRI70597	€ -
7	Resin for chamfer	110	22	2000	DRI70599	€ -
8	Resin for surface	100	22	500	DRI70595	€ -
9	Resin for surface	100	22	1000	DRI70596	€ -
10	Resin for surface	100	22	2000	DRI70598	€ -
11	Resin for surface	100	22	3000	DRI70600	€ -
12	Buffer	100	22	-	DRI70007	€ -

Set Code	DGRIBA60UNIC	€ -
----------	--------------	-----

Wheels replacement

Pos.	Type	Diameter	H	Grit	Code	Price
1	Breaking (stubbing wheel)	85	50+3F	D301	DRI70348	€ -
2	Breaking (stubbing wheel)	85	50+3F	D301	DRI70348	€ -

5	Resin for chamfer	110	Snail lock @	500	DRI70543	€ -
6	Resin for chamfer	110	Snail lock @	1000	DRI70544	€ -
7	Resin for chamfer	110	Snail lock @	2000	DRI70545	€ -

8	Resin for surface	100	Snail lock @	500	DRI70539	€ -
9	Resin for surface	100	Snail lock @	1000	DRI70540	€ -
10	Resin for surface	100	Snail lock @	2000	DRI70541	€ -
11	Resin for surface	100	Snail lock @	3000	DRI70542	€ -

12	Buffer	100	Snail lock @	-	DRI70111	€ -
----	--------	-----	--------------	---	----------	-----

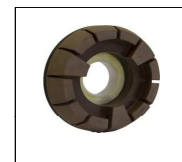

Holder replacement

Pos.	Type	H	Code	Price
1-2	Stubbing wheel holder in inox steel for cone 35 mm	35	D9594	€ -
5-11	Resin wheels holder in alluminum for cone 22 mm	22	D9067	€ -
12	Buffer wheels holder in alluminum for cone 22 mm	22	D9068	€ -
5-11	Resin wheels holder in alluminum for cone 35 mm	35	D9841	€ -
12	Buffer wheels holder in alluminum for cone 35 mm	35	D9258	€ -



Wheels with magnetic connection

Pos.	Type	Diameter	H	Grit	Code	Price
5	Resin for chamfer	110	22	500	DRI70584	€ -
6	Resin for chamfer	110	22	1000	DRI70585	€ -
7	Resin for chamfer	110	22	2000	DRI70586	€ -
8	Resin for surface	100	22	500	DRI70580	€ -
9	Resin for surface	100	22	1000	DRI70581	€ -
10	Resin for surface	100	22	2000	DRI70582	€ -
11	Resin for surface	100	22	3000	DRI70583	€ -



1/2" holder for wheel with magnetic connection	D9824	€ -
--	-------	-----

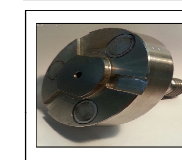

KITCHEN TOP

SET FOR GRANITE WITH CHAMFER 60 DEGREES

Complete set with wheels supports included

Pos.	Type	Diameter	H	Grit	Code	Price
1	Breaking (stubbing wheel)	85	35	D301	DRI70162	€ -
2	Breaking (stubbing wheel)	85	35	D301	DRI70162	€ -
3	Chamfering and surface diam	120	35	D252	DRI70000	€ -
4	Chamfering and surface diam	120	35	D64	DRI70001	€ -
5	Resin for chamfer	125	35	400	DRI70002	€ -
6	Resin for chamfer	125	35	800	DRI70008	€ -
7	Resin for chamfer	125	35	1500	DRI70009	€ -
8	Resin for surface	100	22	500	DRI70011	€ -
9	Resin for surface	100	22	1000	DRI70012	€ -
10	Resin for surface	100	22	2000	DRI70013	€ -
11	Resin for surface	100	22	3000	DRI70014	€ -
12	Buffer	100	22	-	DRI70007	€ -

Set Code	DGRIBA6012M	€ -
----------	-------------	-----

Wheels replacement

Pos.	Type	Diameter	H	Grit	Code	Price
1	Breaking (stubbing wheel)	85	50+3F	D301	DRI70348	€ -
2	Breaking (stubbing wheel)	85	50+3F	D301	DRI70348	€ -

8	Resin for surface	100	Snail lock @	500	DRI70096	€ -
9	Resin for surface	100	Snail lock @	1000	DRI70097	€ -
10	Resin for surface	100	Snail lock @	2000	DRI70098	€ -
11	Resin for surface	100	Snail lock @	3000	DRI70099	€ -

12	Buffer	100	Snail lock @	-	DRI70111	€ -
----	--------	-----	--------------	---	----------	-----

Holder replacement

Pos.	Type	H	Code	Price
1-2	Stubbing wheel holder in inox steel for cone 35 mm	35	D9594	€ -
5-11	Resin wheels holder in alluminum for cone 22 mm	22	D9067	€ -
12	Buffer wheels holder in alluminum for cone 22 mm	22	D9068	€ -
5-11	Resin wheels holder in alluminum for cone 35 mm	35	D9841	€ -
12	Buffer wheels holder in alluminum for cone 35 mm	35	D9258	€ -



DRAIN GROOVE

DRAIN GROOVE ROUTERS Ø 10 MM 1/2" GAS CONNECTION

Pos.	Diameter	Radius	Grit	Code	Price
1	10	4,3	E	DFR00664	€ -
2		4,8	N	DFR00665	€ -
3		5	Q	DFR00666	€ -

Possible grooves:

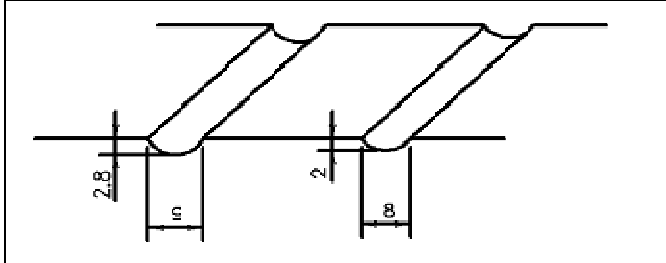

DRAIN GROOVE ROUTERS Ø 12 MM 1/2" GAS CONNECTION

Pos.	Diameter	Radius	Grit	Code	Price
1	12	5,3	E	DFR00959	€ -
2		5,8	N	DFR00960	€ -
3		6	Q	DFR00961	€ -

Possible grooves:

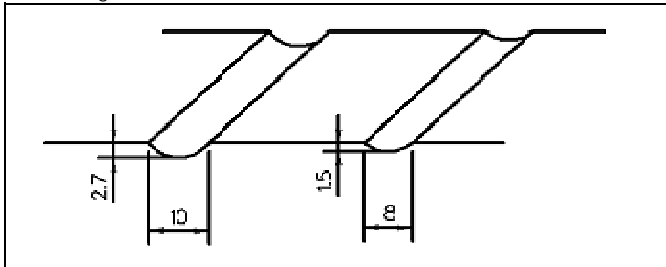

DRAIN GROOVE ROUTERS Ø 14 MM 1/2" GAS CONNECTION

Pos.	Diameter	Radius	Grit	Code	Price
1	14	6,3	E	DFR00629	€ -
2		6,8	N	DFR00630	€ -
3		7	Q	DFR00670	€ -

Possible grooves:

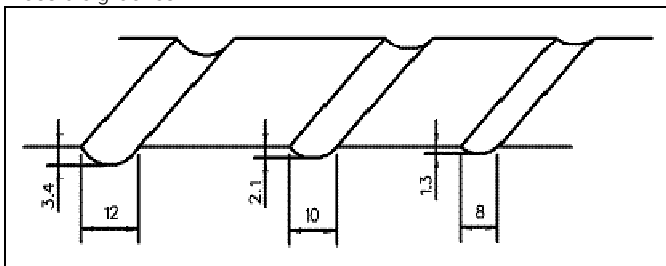

DRAIN GROOVE

DRAIN GROOVE ROUTERS Ø 20 MM 1/2" GAS CONNECTION

Pos.	Diameter	Radius	Grit	Code	Price
1	20	10	E	DFR07052	€ -
2		10	N	DFR07053	€ -
3		10	Q	DFR07054	€ -

Possible grooves:

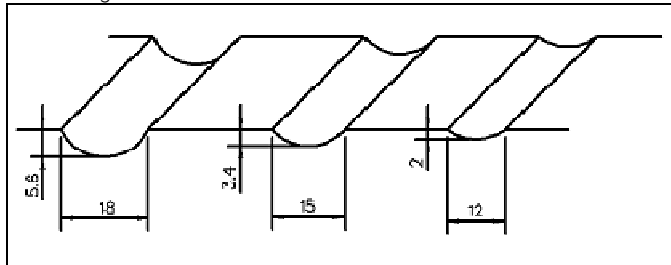

MOLE DA INCISIONE DIAMETRO 140 mm FORO 30 mm INTERMAC

Pos.	T	Radius	Type	Code	Price
1	10	7	Diamonds	DI04196	€ -
2	10	7	Polishing	DLG14648	€ -
1	15	10	Diamonds	DI04316	€ -
2	15	10	Polishing	DLG15089	€ -

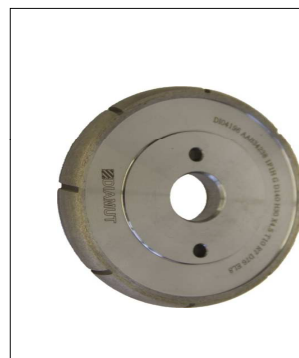

MOLE DA INCISIONE DIAMETRO 150 mm FORO 30mm BIMATECH

Pos.	T	Radius	Type	Code	Price
1	10	7	Diamonds	DI04306	€ -
2	10	7	Polishing	DLG14648	€ -

MOLE DA INCISIONE DIAMETRO 180 mm FORO 22 mm PER BIMATECH

Pos.	T	Radius	Type	Code	Price
1	10	7	Diamonds	DI04307	€ -
2	10	7	Polishing	DLG14996	€ -

STUBBING WHEELS

STANDARD SEGMENT FOR GRANITE AND ENGINEERED STONE

Diameter	Grit	Nr. of Segments	T	Hole	Code	Price
40	D301	7	20	8	DRI70536	€ -
40	D301	7	30	8	DRI70636	€ -
50	D301	12	20	20	DRI70390	€ -
50	D301	12	30	20	DRI70235	€ -
85	D427	20	20	50	DRI70348	€ -
85	D427	20	20	50+4F (BAVELLONI)	DRI70407	€ -
85	D427	14	20	50	DRI70406	€ -
85	D427	20	30	50	DRI70405	€ -
150	D427	37	20	50	DRI70522	€ -
150	D427	35	20	50	DRI70688	€ -

Note: With segments on upper and lower side also



SETTORE STANDARD PER GRANITO TENERO E PIETRE ABRASIVE

Diameter	Grit	Nr. of Segments	T	Hole	Code	Price
85	D301	20	20	50	DRI70482	€ -
85	D427	20	20	50	DRI70475	€ -
150	D427	35	20	50	DRI70652	€ -



GRECATE PER GROSSE ASPORTAZIONI GRANITO E MATERIALI SINTETICI

Diameter	Grit	Nr. of Segments	T	Hole	Code	Price
56	D602	-	30	20	DRI70643	€ -
92	D602	-	30	50	DRI70605	€ -
92	D602	-	30	50+4F (BAVELLONI)	DRI70649	€ -
150	D602	-	30	50	DRI70644	€ -



STUBBING WHEELS VIPER TYPE FOR GRANITE AND ENGINEERED STONE

Diameter	Grit	Nr. of Segments	T	Hole	Code	Price
90	D427	16	30	50	DRI70434	€ -
90	D427	16	30	50+4F (BAVELLONI)	DRI70504	€ -



ELECTROPLATED STUBBING WHEELS FOR MARBLE

Diameter	Grit	Nr. of Segments	T	Hole	Code	Price
50	D602	-	20	10	DRI70227	€ -
85	D602	-	20	50	DRI70055	€ -
85	D602	-	30	50	DRI70494	€ -
150	D602	-	20	50	DRI70645	€ -



STUBBING WHEELS FOR HIGH REMOVAL MARBLE

Diameter	Grit	Nr. of Segments	T	Hole	Code	Price
56	D427	-	30	20	DRI79272	€ 223,00
92	D427	-	30	50	DRI79271	€ 276,00



STUBBING WHEELS
STUBBING WHEELS EXTENSIONS
1/2"GAS connection

Total Length	Working length	Machine cone connection	Wheel fitting	For stubbing wheel	Code	Price
75	50	1/2"GAS	8	Ø 40	D12759	€ -
165	135	1/2"GAS	8	Ø 40	D11010	€ -
59	44	1/2"GAS	10	Ø 50	D9684	€ -
59	44	1/2"GAS	20	Ø 50 - 56	D9528	€ -
55	40	1/2"GAS	50	Ø 85-90-92-150	D10576	€ -
55	55	1/2"GAS	50 / 50+4F	Ø 85-90-92-150	D9788	€ -

Block stone connection for cone ISO40

Total Length	Working length	Machine cone connection	Wheel fitting	For stubbing wheel	Code	Price
149	127	50+6F ISO40	8	Ø 40	D11011	€ -
200	178	50+6F ISO40	10	Ø 50	D10105	€ -
200	178	50+6F ISO40	20	Ø 50 - 56	D10028	€ -
227	205	50+6F ISO40	20	Ø 50 - 56	D10031	€ -
120	120	50+6F ISO40	50 / 50+4F	Ø 85-90-92-150	D9697	€ -
135	135	50+6F ISO40	50 / 50+4F	Ø 85-90-92-150	D10199	€ -
150	150	50+6F ISO40	50 / 50+4F	Ø 85-90-92-150	D6953	€ -
250	250	50+6F ISO40	50 / 50+4F	Ø 85-90-92-150	D12635	€ -

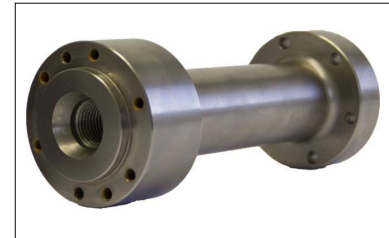
Block stone connection for cone ISO40 NILOY processing anticorrosion

Total Length	Working length	Machine cone connection	Wheel fitting	For stubbing wheel	Code	Price
100	100	50+6F ISO40	50 / 50+4F	Ø 85-90-92-150	D9286	€ -
170	170	50+6F ISO40	50 / 50+4F	Ø 85-90-92-150	D9180	€ -
200	200	50+6F ISO40	50 / 50+4F	Ø 85-90-92-150	D9224	€ -
225	225	50+6F ISO40	50 / 50+4F	Ø 85-90-92-150	D9092	€ -
300	300	50+6F ISO40	50 / 50+4F	Ø 85-90-92-150	D10124	€ -
400	400	50+6F ISO40	50 / 50+4F	Ø 85-90-92-150	D10194	€ -

Block stone connection for cone ISO50 for stubbing wheels and 1/2"GAS connection

Total Length	Working length	Machine cone connection	Wheel fitting	For stubbing wheel	Code	Price
150	150	50+6F ISO50	50	Ø 85-90-92-150	D12104	€ -
170	170	50+6F ISO50	50	Ø 85-90-92-150	D12623	€ -
200	200	50+6F ISO50	50	Ø 85-90-92-150	D12115	€ -
250	250	50+6F ISO50	50	Ø 85-90-92-150	D12105	€ -
300	300	50+6F ISO50	50	Ø 85-90-92-150	D12044	€ -
350	350	50+6F ISO50	50	Ø 85-90-92-150	D12622	€ -
430	430	50+6F ISO50	50	Ø 85-90-92-150	D12045	€ -
450	450	50+6F ISO40	50	Ø 85-90-92-150	D12106	€ -



TOOLS FOR WRITING

#N/D

Angle	Body diameter	Bit diameter	Total Length	Code	Price
30	10	10	55	DFFR00776	€ -
60	10	10	55	DFFR00568	€ -
90	10	10	55	DFFR00606	€ -

Holder with 1/2"GAS connection for writing bits	DFR00636	€ -
---	----------	-----



WRITING BIT IN PCD FOR GRANITE

Angle	Body diameter	Bit diameter	Total Length	Code	Price
35	10	10	63	DFFR90192	€ -
60	10	10	63	DFFR90354	€ -
70	10	10	63	DFFR90061	€ -
90	10	10	63	DFFR90027	€ -
105	10	10	63	DFFR90237	€ -
120	10	10	63	DFFR00103	€ -

Holder with 1/2"GAS connection for writing bits	DFR00636	€ -
---	----------	-----



BAS-RELIEF CONICAL BIT IN PCD FOR GRANITE LEFT

Angle	Diamètre corps	Diamètre coupe	Longueur totale	Code	Prix
70	10	10	55	DFFR90728	€ -
90	10	10	55	DFFR90727	€ -

Holder with 1/2"GAS connection for writing bits	DFR02885	€ 77,00
---	----------	---------

TOOLS FOR ENGRAVING AND SCULPTURE

ELECTROPLATED BITS FOR MARBLE ENGRAVING

Conical

Angle	D1	D2	L1	L2	Code	Price
14	5	6	15	60	DFFR00666	€ -
14	9	6	36	60	DFFR00667	€ -
30	10	6	20	60	DFFR90209	€ -
60	6	6	5,2	60	DFFR00694	€ -
60	10	6	8,5	60	DFFR00695	€ -

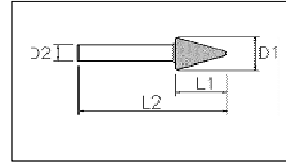

Cylindrical

D1	D2	L1	L2	Code	Price
3	6	12	60	DFFR00023	€ -
4	6	12	60	DFFR00713	€ -
6	6	12	60	DFFR00692	€ -
10	6	12	60	DFFR00693	€ -

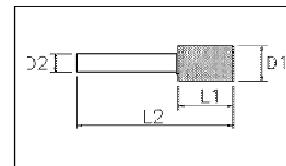

Rounded

D1	D2	L	Code	Price
6	6	60	DFFR00664	€ -
10	6	60	DFFR00665	€ -
16	6	60	DFFR00013	€ -

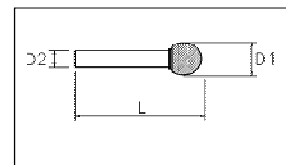

Rounded

Type	Code	Price
1/2" GAS universal adapter for shank 6-8-10 mm - Picture A	DFFR00729	€ -
1/2" GAS holder shank 6 mm (for electroplated bits) - Picture B	DFR00590	€ -



B

BAS-RELIEF CONICAL BIT IN PCD FOR GRANITE

Ø	Ø _e	R	L	Lu	Code	Price
8		4	15		DFFR90721	€ -
5		2,5	15		DFFR90722	€ -

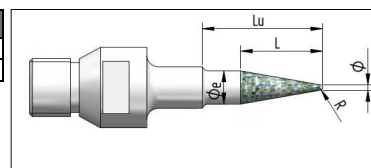

Bas-relief conical bit in tungsten carbide for soft marble

Ø	Ø _e	R	L	Lu	Code	Price
11	20	5,5	40	72	DFFR00615	€ -
6	18	3	28	68	DFFR00616	€ -
5	12	2,5	50	64	DFFR90193	€ -

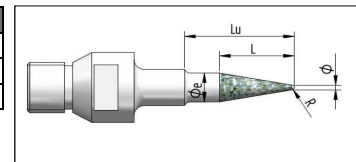

Bas-relief conical bit in tungsten carbide for hard marble

Ø	Ø _e	R	L	Lu	Code	Price
11	20	5,5	40	72	DFFR00617	€ -
6	18	3	28	68	DFFR00618	€ -
5	12	2,5	50	64	DFFR90194	€ -

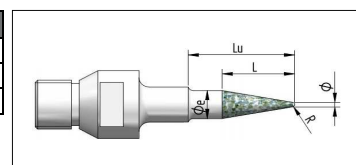

TOOLS FOR ENGRAVING AND SCULPTURE

Bas-relief conical bit in tungsten carbide two sharps for marble

Ø	Øe	R	L	Lu	Code	Price
8*		4	50		DFFR00004	€ -
5	18	2,5	50	78	DFFR00003	€ -
3		1,5	30		DFFR90718	€ -
3	15	1,5	50	80	DFFR90019	€ -
3*	15	1,5	50	80	DFFR90726	€ -
3		1,5	30+110	110	DFFR90724	€ -

* Con passaggio acqua / with internal cooling

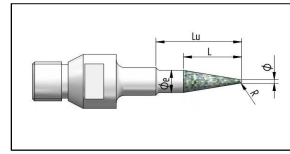

Bas-relief conical bit in tungsten carbide spiral shape for marble

Ø	Øe	R	L	Lu	Code	Price
5	12	2,5	50	50	DFFR90719	€ -
3	10	1,5	50	50	DFFR90720	€ -

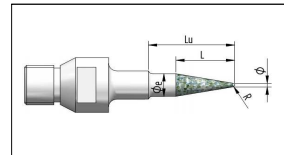

TOOLS FOR BEVEL

CUP WHEELS DIAMETER 150 MM HOLE 22 MM V0 (INTERMAC)

Position	Type	Grit	Code	Price
1	Diamond segmented	D427	DTB00066	€ -
2	Diamond segmented	D181	DTB00099	€ -
3	Turbo resin	D91	DTB00207	€ -
4	Turbo resin	D54	DTB00208	€ -
5	Turbo resin	600	DTB00209	€ -
6	Turbo resin	800	DTB00210	€ -
7	Turbo resin	1000	DTB00211	€ -
8	Turbo resin	2000	DTB00212	€ -
9	Turbo resin	3000	DTB00213	€ -
10	Buffer	-	DLG17638	€ -



CUP WHEELS DIAMETER 150 MM HOLE 22 MM V3 (INTERMAC)

Position	Type	Grit	Code	Price
1	Diamond segmented	D427	DTB00066	€ -
2	Diamond segmented	D181	DTB00099	€ -
3	Turbo resin	D91	DTB00220	€ -
4	Turbo resin	D54	DTB00221	€ -
5	Turbo resin	600	DTB00222	€ -
6	Turbo resin	800	DTB00223	€ -
7	Turbo resin	1000	DTB00224	€ -
8	Turbo resin	2000	DTB00225	€ -
9	Turbo resin	3000	DTB00226	€ -
10	Buffer	-	DLG13993	€ -

CUP WHEELS DIAMETER 150 MM HOLE 22 MM V7 (INTERMAC)

Position	Type	Grit	Code	Price
1	Diamond segmented	D427	DTB00066	€ -
2	Diamond segmented	D181	DTB00099	€ -
3	Turbo resin	D91	DTB00192	€ -
4	Turbo resin	D54	DTB00183	€ -
5	Turbo resin	600	DTB00193	€ -
6	Turbo resin	800	DTB00194	€ -
7	Turbo resin	1000	DTB00182	€ -
8	Turbo resin	2000	DTB00184	€ -
9	Turbo resin	3000	DTB00185	€ -
10	Buffer	-	DLG17515	€ -

TOOLS FOR SINK WORKING

FOR GRANITE WITH BLOCK STONE CONNECTION ISO40

Position	Diameter	R	L	L1	Code	Price
1	50	20	160	50	DLM70061	€ -
2	50	20	160	50	DLM70062	€ -
1	80	25	225	50	DLM70035	€ -
2	80	25	225	50	DLM70036	€ -
3	80	25	225	50	DLM70037	€ -

FOR GRANITE WITH 1/2"GAS CONNECTION

Position	Diameter	R	L	L1	Code	Price
1	85	20	90	50	DLM70141	€ -

FOR MARBLE - ELECTROPLATED DIAMOND HEADS

Position	Diameter	R	L	L1	Code	Price
1	85	20	60	-	DLM70018	€ -
2	85	20	60	-	DLM70019	€ -
3	85	20	60	-	DLM70020	€ -

Flange extensions ISO40 for marmble elctroplated diamond heads

Total Length	Working length	Code	Price
120	120	D9697	€ -
135	135	D10199	€ -
150	150	D6953	€ -
250	250	D12635	€ -

Flange extensions ISO40 for marmble elctroplated diamond heads NIPLOY processing anticorrosion

Total Length	Working length	Code	Price
100	100	D9286	€ -
170	170	D9180	€ -
200	200	D9224	€ -
225	225	D9092	€ -
300	300	D10124	€ -
400	400	D10194	€ -



TOOLS FOR SURFACE POLISHING WITH CNC MACHINES

DIAMETER 250 MM FOR FLAT SURFACES GRANITE AND ENGINEERED STONE

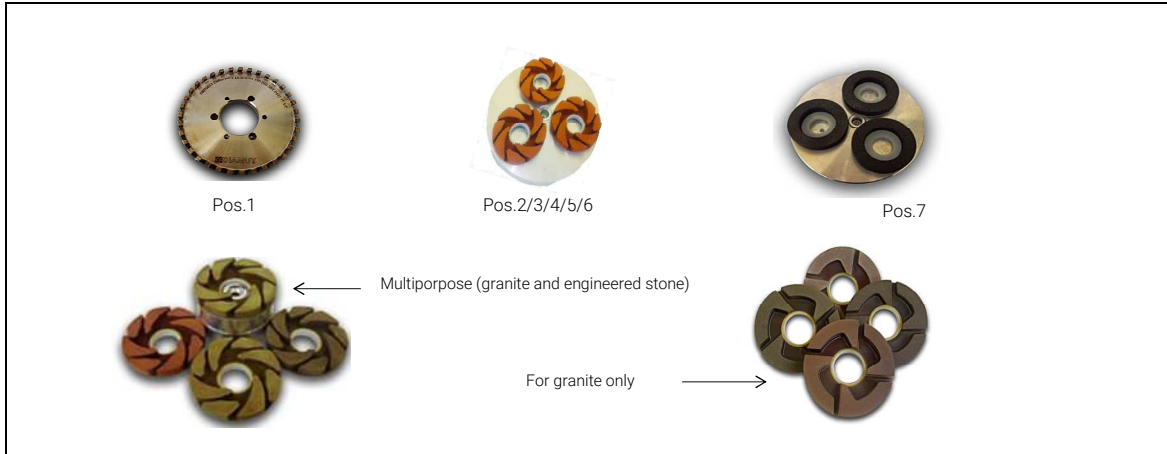

Position	Type	Grit	Diameter	H	Code	Price
1	Stubbing Wheels	D427	150	50	DRI70652	€ -
Stubbing wheel holder in inox steel for cone 35 mm			---	35	D9594	€ -

Multipurpose (granite and engineered stone)

Position	Type	Grit	Diameter	H	Code	Price
2	Resin for surface	200	100	Snail lock @	DRI70554	€ -
3	Resin for surface	500	100	Snail lock @	DRI70539	€ -
4	Resin for surface	1000	100	Snail lock @	DRI70540	€ -
5	Resin for surface	2000	100	Snail lock @	DRI70541	€ -
6	Resin for surface	3000	100	Snail lock @	DRI70542	€ -
7	Buffer	-	100	Snail lock @	DRI70111	€ -

Note: For 2/3/4/5/6/7 q.ty 3 needed, price indicated is for pcs.1

For granite only

Position	Type	Grit	Diameter	H	Code	Price
2	Resin for surface	200	100	Snail lock @	DRI70130	€ -
3	Resin for surface	500	100	Snail lock @	DRI70096	€ -
4	Resin for surface	1000	100	Snail lock @	DRI70097	€ -
5	Resin for surface	2000	100	Snail lock @	DRI70098	€ -
6	Resin for surface	3000	100	Snail lock @	DRI70099	€ -
7	Buffer	-	100	Snail lock @	DRI70111	€ -

Note: For 2/3/4/5/6/7 q.ty 3 needed, price indicated is for pcs.1

Holder

2-7	Resin wheels holder in alluminum for cone 35 mm	D12075	€ -
-----	---	--------	-----

TOOLS FOR SURFACE POLISHING WITH CNC MACHINES

DIAMETER 150 MM FOR INCLINED SURFACES MAX EXTENSION 150 MM GRANITE AND ENGINEERED STONE



Position	Type	Grit	Diameter	H	Code	Price
1	Stubbing Wheels	D427	92	50	DRI70605	€ -
2	Resin polishing plate	D181	150	Snail lock @	DRI70681	€ -
3	Resin polishing plate	D91	150	Snail lock @	DRI70682	€ -
4	Resin polishing plate	500	150	Snail lock @	DRI70683	€ -
5	Resin polishing plate	1000	150	Snail lock @	DRI70684	€ -
6	Resin polishing plate	2000	150	Snail lock @	DRI70685	€ -
7	Resin polishing plate	3000	150	Snail lock @	DRI70686	€ -
8	Resin polishing plate	Buffer	150	Snail lock @	DRI70687	€ -

Holder Pos.1 for cone bore 35 mm	D9594	€ -
Holder Pos.2-8 for cone bore 35 mm	D9666	€ -

TOOLS FOR ANTIQUE FINISHING

BRUSHES FOR SURFACE ANTIQUE FINISHING DIAMETER 130 MM

Position	Grana	Diameter	H	Minimum step	Code	Price
1	Metal	130	Snail lock @	✓	DLG16538	€ -
2	46	130	Snail lock @	✓	DLG15000	€ -
3	60	130	Snail lock @		DLG15001	€ -
4	80	130	Snail lock @		DLG15002	€ -
5	120	130	Snail lock @	✓	DLG15003	€ -
6	240	130	Snail lock @		DLG15004	€ -
7	320	130	Snail lock @	✓	DLG15005	€ -
8	500	130	Snail lock @	✓	DLG15006	€ -



Holder Pos.1-8 for cone bore 35 mm	D9666	€ -
------------------------------------	-------	-----

BRUSHES FOR SURFACE ANTIQUE FINISHING DIAMETER 100 MM

Position	Grana	Diameter	H	Minimum step	Code	Price
1	Metal	100	Snail lock @	✓	DLG16537	€ -
2	46	100	Snail lock @	✓	DLG15010	€ -
3	60	100	Snail lock @		DLG15011	€ -
4	80	100	Snail lock @		DLG15012	€ -
5	120	100	Snail lock @	✓	DLG15013	€ -
6	240	100	Snail lock @		DLG15014	€ -
7	320	100	Snail lock @	✓	DLG15015	€ -
8	500	100	Snail lock @	✓	DLG15016	€ -



Holder Pos.1-8 for cone bore 35 mm	D9665	€ -
------------------------------------	-------	-----

BRUSHES FOR EDGE ANTIQUE FINISHING DIAMETER 150 MM

Position	Grana	Diameter	H	T	Code	Price
1	46	150	22	60	DLG15035	€ -
2	120	150	22	60	DLG15036	€ -
3	240	150	22	60	DLG15037	€ -

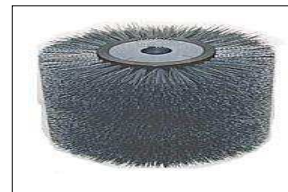

TOOLS FOR INTERNAL SINK HOLE POLISHING WITH AGGREGATE ON CNC

FOR INTERMAC AGGREGATE GRANITE AND ENGINEERED STONE



Position	Type	Grana	Diameter	H	Code	Price
1	Metallic	D107	160	70	DRI70509	€ -
2	Metallic	D76	160	70	DRI70566	€ -
3	Resin polishing plate	500	150	Snail lock @	DRI79218	€ -
4	Resin polishing plate	1000	150	Snail lock @	DRI79219	€ -
5	Resin polishing plate	2000	150	Snail lock @	DRI79220	€ -
6	Resin polishing plate	3000	150	Snail lock @	DRI79221	€ -

Set Code	DGFORISQUADRATI2014	€ -
----------	---------------------	-----

DIAMOND TOOLS FOR EDGE POLISHER MACHINES

DIAMOND WHEELS TYPOLOGY AVAILABLE ON CATALOGUE

Picture	Type
	Calibrating Wheel
	Calibrating Wheel
	Pre-Cutting Wheel
	Generating Wheel
	Generating Wheel

DIAMOND TOOLS FOR EDGE POLISHER MACHINES

COMANDULLI

Machine	Tool	Dimensions	Wheel fitting	Code	Price
EDILUX	Calibrating Wheel	260X18X50	50+4F	DLC00048	€ -
	Arris Generating Wheel	100x47xM30	M30	DLC00093	€ -
SYNTHESIS	Calibrating Wheel	260X18X50	50+4F	DLC00048	€ -
	Pre-Cutting Wheel	155X45X50 V30	50+4F	DLC00012	€ -
	Generating Wheel	130x53xM30	M30	DLC00013	€ -
OMEGA 60/100	Calibrating Wheel	260X18X50	50+4F	DLC00048	€ -
	Pre-Cutting Wheel	155X45X50 V30	50+4F	DLC00012	€ -
	Generating Wheel	130x53xM30	M30	DLC00013	€ -
NEW SYSTEM 180 SPEEDY SYSTEM	Generating wheel (with automatic tool change system)	120X20X65	40+4F	DLC00043	€ -
	Generating wheel (without automatic tool change system)	120X44X65 M24 V90	M24	DLC00044	€ -
ATHENA SYSTEM PLUS	Generating wheel (with automatic tool change system)	120X20X65	40+4F	DLC00043	€ -
SYSTEM 180	Generating Wheel	120X47X50 M18 V90	M18	DLC00032	€ -
ALMA	Calibrating Wheel	190X27X50	50+4F	DLC00045	€ -
	Pre-Cutting Wheel	155X45X50 V30	50+4F	DLC00012	€ -
	Generating Wheel	130x53xM30	M30	DLC00013	€ -
MUSA	Calibrating Wheel	190X27X50	50+4F	DLC00045	€ -
PENTA	Calibrating Wheel	190X27X50	50+4F	DLC00045	€ -
LUX LINE	Calibrating Wheel	260X18X50	50+4F	DLC00048	€ -
SPIRA	Calibrating Wheel	190X27X50	50+4F	DLC00045	€ -
OPTIMA	Calibrating Wheel	190X27X50	50+4F	DLC00045	€ -

MONTRESOR

Machine	Tool	Dimensions	Wheel fitting	Code	Price
LOLA 40/800/1000	Calibrating Wheel right side	250X20X50	50+4F	DLC00050	€ -
	Arris Generating Wheel	130X40 M30 V20	M30	DLC00094	€ -
	Calibrating Wheel left side	250X20X50 SX	50+4F	DLC00055	€ -
LUNA	Calibrating Wheel	250X20X50 DX	50+4F	DLC00050	€ -
	Calibrating Wheel	250X20X50 SX	50+4F	DLC00055	€ -
	Pre-Cutting Wheel	130X68X94 M30 V60	M30	DLC00039	€ -
	Pre-Cutting Wheel-internal removal	150X68X73 M30 V60	M30	DLC00103	€ -
	Pre-Cutting Wheel-internal removal	130X68X73 M30 V60	M30	DLC00040	€ -
	Generating Wheel	155X60X42 M30 V45	M30	DLC00102	€ -
	Arris Generating Wheel	130X40 M30 V20	M30	DLC00094	€ -
LARA	Calibrating Wheel right side	200X22X50	50	DLC00056	€ -
	Calibrating Wheel left side	200X22X50	50	DLC00057	€ -
	Calibrating Wheel	300X20X50	50+4F	DLC00058	€ -
	Pre-Cutting Wheel	130X68X94 M30 V60	M30	DLC00039	€ -
	Pre-Cutting Wheel-internal removal	130X68X73 M30 V60	M30	DLC00040	€ -
	Generating Wheel	130X57X35 M30 V60	M30	DLC00060	€ -
	Generating Wheel Pos.2	130X57X35 M30 V60	M30	DLC00061	€ -
UNICA 810 4A	Calibrating Wheel right side	300X20X50	50+4F	DLC00058	€ -
	Calibrating Wheel left side	300X20X50	50+4F	DLC00059	€ -
	Pre-Cutting Wheel	150X74X100 M30 V60	M30	DLC00062	€ -
VELA	Arris Generating Wheel	130X20X125 - 35°	125	DLC00107	€ -

DIAMOND TOOLS FOR EDGE POLISHER MACHINES
MONTRESOR

Blades	Blades for Marble	250X4- Nor.	50+4F+4F	DLC00106	€ -
		250X3,2 - Sil.	50+4F+4F	DLC00113	€ -
	Blades for Granite	250X4 - Nor.	50+4F+4F	DLC00115	€ -
		250X3,2- Sil.	50+4F+4F	DLC00114	€ -
Machine	Tool	Grit	Wheel fitting	Code	Price
Diameter 150 mm - Snail Lock @ - Flat Edge - Granite and Engineered Stone	Resin polishing wheels for edge polisher machines	280	Snail lock @	DLC20137	€ -
		400	Snail lock @	DLC20138	€ -
		600	Snail lock @	DLC20139	€ -
		800	Snail lock @	DLC20140	€ -
		1500	Snail lock @	DLC20141	€ -

SASSO MECCANICA

Machine	Tool	Dimensions	Wheel fitting	Code	Price
FLYNG FLAT	Combi wheel	160x130		DLC00081	€ -
RCM TE	Combi wheel	160x130		DLC00081	€ -
	Pre-Cutting Wheel	130X30X95	95+6F	DLC00083	€ -
	Generating Wheel	130X20X95	95+6F	DLC00082	€ -
EXPERIENCE TE	Calibrating Wheel	135X95		DLC00080	€ -
	Pre-Cutting Wheel	130X30X95	95+6F	DLC00083	€ -
	Generating Wheel	130X20X95	95+6F	DLC00082	€ -
	Blade for grooving	150X8X10	50	DLC00079	€ -
EXPERIENCE FULL TE	Calibrating Wheel	135X95		DLC00080	€ -
	Pre-Cutting Wheel	130X30X95	95+6F	DLC00083	€ -
	Generating Wheel	130X20X95	95+6F	DLC00082	€ -
	Blade for grooving	160X8X10	50	DLC00079	€ -

BRETON

Machine	Tool	Dimensions	Wheel fitting	Code	Price
PLATINUM	Pre-Cutting Wheel	130X36X94	120+6F	DLC00047	€ -
	Generating Wheel	130X67X35 M30 V60	M30	DLC00046	€ -
EASY	Generating Wheel	170X65X100	50+4F	DLC00049	€ -

PARK INDUSTRIES

Machine	Tool	Dimensions	Wheel fitting	Code	Price
PRO EDGE	Generating Wheel	100X25X50	Snail Lock	DLC00028	€ -
	Generating Wheel Pos.2	100X25X50	Snail Lock	DLC00029	€ -
VELOCITY	Generating Wheel	150X21X70 V60	125+4F	DLC00084	€ -
	Pre-Cutting Wheel	155X30 V60	34X117+4F	DLC00085	€ -

RESIN POLISHING WHEELS FOR EDGE POLISHER MACHINES

DIAMETER 130 MM - SNAIL LOCK @ - FLAT EDGE - GRANITE AND ENGINEERED STONE

Grit	Description	Code	Price
30	WHEEL RES FLAT D.130 @ GR.30	DLC20001	€ -
60	WHEEL RES FLAT D.130 @ GR.60	DLC20002	€ -
120	WHEEL RES FLAT D.130 @ GR.120	DLC20003	€ -
220	WHEEL RES FLAT D.130 @ GR.220	DLC20004	€ -
400	WHEEL RES FLAT D.130 @ GR.400	DLC20007	€ -
600	WHEEL RES FLAT D.130 @ GR.600	DLC20008	€ -
800	WHEEL RES FLAT D.130 @ GR.800	DLC20009	€ -
1800	WHEEL RES FLAT D.130 @ GR.1800	DLC20010	€ -
3500	WHEEL RES FLAT D.130 @ GR.3500	DLC20011	€ -
Buffer - Granite	WHEEL RES FLAT D.130 @ GR.LUX	DLC20012	€ -
Extra Engineered	WHEEL RES FLAT D.130 @ GR.5000S	DLC20097	€ -



DIAMETER 130 MM - LEFT SNAIL LOCK @ - FLAT EDGE - GRANITE AND ENGINEERED STONE

Grit	Description	Code	Price
30	WHEEL RES FLAT D.130 @ SX GR.30	DLC20013	€ -
60	WHEEL RES FLAT D.130 @ SX GR.60	DLC20014	€ -
120	WHEEL RES FLAT D.130 @ SX GR.120	DLC20015	€ -
220	WHEEL RES FLAT D.130 @ SX GR.220	DLC20016	€ -
400	WHEEL RES FLAT D.130 @ SX GR.400	DLC20019	€ -
600	WHEEL RES FLAT D.130 @ SX GR.600	DLC20020	€ -
800	WHEEL RES FLAT D.130 @ SX GR.800	DLC20021	€ -
1800	WHEEL RES FLAT D.130 @ SX GR.1800	DLC20022	€ -
3500	WHEEL RES FLAT D.130 @ SX GR.3500	DLC20023	€ -
Buffer - Granite	WHEEL RES FLAT D.130 @ SX GR.LUX	DLC20024	€ -
Extra Engineered	WHEEL RES FLAT D.130 @ SX GR.5000S	DLC20098	€ -

DIAMETER 130 MM - SNAIL LOCK @ - BULL NOSE - GRANITE AND ENGINEERED STONE

Grit	Description	Code	Price
30	WHEEL RES BN D.130 @ GR.30	DLC20025	€ -
60	WHEEL RES BN D.130 @ GR.60	DLC20026	€ -
120	WHEEL RES BN D.130 @ GR.120	DLC20027	€ -
220	WHEEL RES BN D.130 @ GR.220	DLC20028	€ -
280	WHEEL RES BN D.130 @ GR.280	DLC20029	€ -
320	WHEEL RES BN D.130 @ GR.320	DLC20030	€ -
400	WHEEL RES BN D.130 @ GR.400	DLC20031	€ -
600	WHEEL RES BN D.130 @ GR.600	DLC20032	€ -
800	WHEEL RES BN D.130 @ GR.800	DLC20033	€ -
1800	WHEEL RES BN D.130 @ GR.1800	DLC20034	€ -
3500	WHEEL RES BN D.130 @ GR.3500	DLC20035	€ -
Buffer - Granite	WHEEL RES BN D.130 @ GR.LUX	DLC20036	€ -
Extra Engineered	WHEEL RES BN D.130 @ GR.5000S	DLC20099	€ -



NOTA: Grane 30 e 60 per macchine monotesta

DIAMETER 130 MM - LEFT SNAIL LOCK @ - BULL NOSE - GRANITE AND ENGINEERED STONE

Grit	Description	Code	Price
30	WHEEL RES BN D.130 @ SX GR.30	DLC20037	€ -
60	WHEEL RES BN D.130 @ SX GR.60	DLC20038	€ -
120	WHEEL RES BN D.130 @ SX GR.120	DLC20039	€ -
220	WHEEL RES BN D.130 @ SX GR.220	DLC20040	€ -
280	WHEEL RES BN D.130 @ SX GR.280	DLC20041	€ -
320	WHEEL RES BN D.130 @ SX GR.320	DLC20042	€ -
400	WHEEL RES BN D.130 @ SX GR.400	DLC20043	€ -
600	WHEEL RES BN D.130 @ SX GR.600	DLC20044	€ -
800	WHEEL RES BN D.130 @ SX GR.800	DLC20045	€ -
1800	WHEEL RES BN D.130 @ SX GR.1800	DLC20046	€ -
3500	WHEEL RES BN D.130 @ SX GR.3500	DLC20047	€ -
Buffer - Granite	WHEEL RES BN D.130 @ SX GR.LUX	DLC20048	€ -
Extra Engineered	WHEEL RES BN D.130 @ SX GR.5000S	DLC20100	€ -

NOTA: Grane 30 e 60 per macchine monotesta

All the prices are in: EURO

RESIN POLISHING WHEELS FOR EDGE POLISHER MACHINES

DIAMETER 150 MM - SNAIL LOCK @ - ECCENTRIC WHEEL - FLAT EDGE - GRANITE AND ENGINEERED STONE

Grit	Description	Code	Price
30	WHEEL RES FLAT ECC D.150 @ GR.30	DLC20049	€ -
60	WHEEL RES FLAT ECC D.150 @ GR.60	DLC20050	€ -
120	WHEEL RES FLAT ECC D.150 @ GR.120	DLC20051	€ -
220	WHEEL RES FLAT ECC D.150 @ GR.220	DLC20052	€ -
400	WHEEL RES FLAT ECC D.150 @ GR.400	DLC20055	€ -
600	WHEEL RES FLAT ECC D.150 @ GR.600	DLC20056	€ -
800	WHEEL RES FLAT ECC D.150 @ GR.800	DLC20057	€ -
1800	WHEEL RES FLAT ECC D.150 @ GR.1800	DLC20058	€ -
3500	WHEEL RES FLAT ECC D.150 @ GR.3500	DLC20059	€ -
Buffer - Granite	WHEEL RES FLAT ECC D.150 @ GR.LUX	DLC20060	€ -
Extra Engineered	WHEEL RES FLAT ECC D.150 @ GR.5000S	DLC20101	€ -



DIAMETER 150 MM - LEFT SNAIL LOCK @ - ECCENTRIC WHEEL - FLAT EDGE - GRANITE AND ENGINEERED STONE

Grit	Description	Code	Price
30	WHEEL RES FLAT ECC D.150 @ SX GR.30	DLC20061	€ -
60	WHEEL RES FLAT ECC D.150 @ SX GR.60	DLC20062	€ -
120	WHEEL RES FLAT ECC D.150 @ SX GR.120	DLC20063	€ -
220	WHEEL RES FLAT ECC D.150 @ SX GR.220	DLC20064	€ -
400	WHEEL RES FLAT ECC D.150 @ SX GR.400	DLC20067	€ -
600	WHEEL RES FLAT ECC D.150 @ SX GR.600	DLC20068	€ -
800	WHEEL RES FLAT ECC D.150 @ SX GR.800	DLC20069	€ -
1800	WHEEL RES FLAT ECC D.150 @ SX GR.1800	DLC20070	€ -
3500	WHEEL RES FLAT ECC D.150 @ SX GR.3500	DLC20071	€ -
Buffer - Granite	WHEEL RES FLAT ECC D.150 @ SX GR.LUX	DLC20072	€ -
Extra Engineered	WHEEL RES FLAT ECC D.150 @ SX GR.5000S	DLC20102	€ -

DIAMETER 150 MM - SNAIL LOCK @ - ECCENTRIC WHEEL - BULL NOSE - GRANITE AND ENGINEERED STONE

Grit	Description	Code	Price
30	WHEEL RES BN ECC D.150 @ GR.30	DLC20073	€ -
60	WHEEL RES BN ECC D.150 @ GR.60	DLC20074	€ -
120	WHEEL RES BN ECC D.150 @ GR.120	DLC20075	€ -
220	WHEEL RES BN ECC D.150 @ GR.220	DLC20076	€ -
280	WHEEL RES BN ECC D.150 @ GR.280	DLC20077	€ -
320	WHEEL RES BN ECC D.150 @ GR.320	DLC20078	€ -
400	WHEEL RES BN ECC D.150 @ GR.400	DLC20079	€ -
600	WHEEL RES BN ECC D.150 @ GR.600	DLC20080	€ -
800	WHEEL RES BN ECC D.150 @ GR.800	DLC20081	€ -
1800	WHEEL RES BN ECC D.150 @ GR.1800	DLC20082	€ -
3500	WHEEL RES BN ECC D.150 @ GR.3500	DLC20083	€ -
Buffer - Granite	WHEEL RES BN ECC D.150 @ GR.LUX	DLC20084	€ -
Extra Engineered	WHEEL RES BN ECC D.150 @ GR.5000S	DLC20103	€ -



Note: Grit 30 and 60 for single head machines

DIAMETER 150 MM - LEFT SNAIL LOCK @ - ECCENTRIC WHEEL - BULL NOSE - GRANITE AND ENGINEERED STONE

Grit	Description	Code	Price
30	WHEEL RES BN ECC D.150 @ SX GR.30	DLC20085	€ -
60	WHEEL RES BN ECC D.150 @ SX GR.60	DLC20086	€ -
120	WHEEL RES BN ECC D.150 @ SX GR.120	DLC20087	€ -
220	WHEEL RES BN ECC D.150 @ SX GR.220	DLC20088	€ -
280	WHEEL RES BN ECC D.150 @ SX GR.280	DLC20089	€ -
320	WHEEL RES BN ECC D.150 @ SX GR.320	DLC20090	€ -
400	WHEEL RES BN ECC D.150 @ SX GR.400	DLC20091	€ -
600	WHEEL RES BN ECC D.150 @ SX GR.600	DLC20092	€ -
800	WHEEL RES BN ECC D.150 @ SX GR.800	DLC20093	€ -
1800	WHEEL RES BN ECC D.150 @ SX GR.1800	DLC20094	€ -
3500	WHEEL RES BN ECC D.150 @ SX GR.3500	DLC20095	€ -
Buffer - Granite	WHEEL RES BN ECC D.150 @ SX GR.LUX	DLC20096	€ -
Extra Engineered	WHEEL RES BN ECC D.150 @ SX GR.5000S	DLC20104	€ -

Note: Grit 30 and 60 for single head machines

RESIN POLISHING WHEELS FOR EDGE POLISHER MACHINES

DIAMETER 150 MM - SNAIL LOCK @ - FLAT EDGE - GRANITE AND ENGINEERED STONE

Grit	Description	Code	Price
30	WHEEL RES FLAT D.150 @ GR.30	DLC20110	€ -
60	WHEEL RES FLAT D.150 @ GR.60	DLC20111	€ -
120	WHEEL RES FLAT D.150 @ GR.120	DLC20112	€ -
220	WHEEL RES FLAT D.150 @ GR.220	DLC20113	€ -
400	WHEEL RES FLAT D.150 @ GR.400	DLC20114	€ -
600	WHEEL RES FLAT D.150 @ GR.600	DLC20115	€ -
800	WHEEL RES FLAT D.150 @ GR.800	DLC20116	€ -
1800	WHEEL RES FLAT D.150 @ GR.1800	DLC20117	€ -
3500	WHEEL RES FLAT D.150 @ GR.3500	DLC20118	€ -
Buffer - Granite	WHEEL RES FLAT D.150 @ GR.LUX	DLC20119	€ -
Extra Engineered	WHEEL RES FLAT D.150 @ GR.5000S	DLC20120	€ -



DIAMETER 130 MM - SNAIL LOCK @ - ARRIS - GRANITE AND ENGINEERED STONE

Grit	Description	Code	Price
220	WHEEL RES FLAT D.130 ARRIS @ GR.220	DLC20105	€ -
320	WHEEL RES FLAT D.130 ARRIS @ GR.320	DLC20106	€ -
400	WHEEL RES FLAT D.130 ARRIS @ GR.400	DLC20107	€ -
600	WHEEL RES FLAT D.130 ARRIS @ GR.600	DLC20108	€ -

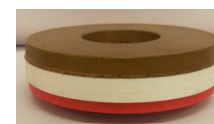
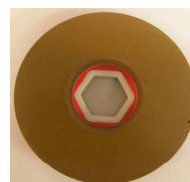

GRIT SIZE SUGGESTED SEQUENCES FOR FLAT EDGE

5 polishing heads machine

Granite and Marble
Engineered Stone

60 # 120 # 400 # 1800 # Buffer
120 # 220 # 400 # 800 # Extra Engineered

6 polishing heads machine

Granite and Marble
Marble
Engineered Stone

60 # 120 # 400 # 800 # 1800 # Buffer
60 # 120 # 400 # 800 # 1800 # 3500
60 # 120 # 400 # 800 # 1800 # Extra Engineered

7 polishing heads machine

Granite and Marble
Marble
Engineered Stone

60 # 120 # 220 # 400 # 800 # 1800 # Buffer
60 # 120 # 220 # 400 # 800 # 1800 # 3500
120 # 220 # 400 # 800 # 1800 # Extra Engineered

GRIT SIZE SUGGESTED SEQUENCES FOR BULL NOSE

5 polishing heads machine

Granite and Marble
Marble
Engineered Stone

220 # 400 # 600 # 800 # Buffer
220 # 400 # 600 # 800 # 3500
220 # 400 # 600 # 800 # Extra Engineered

6 polishing heads machine

Granite and Marble
Marble
Engineered Stone

220 # 320 # 400 # 600 # 800 # Buffer
220 # 320 # 400 # 600 # 800 # 3500
220 # 320 # 400 # 600 # 800 # Extra Engineered

7 polishing heads machine

Granite and Marble
Marble
Engineered Stone

220 # 280 # 320 # 400 # 600 # 800 # Buffer
220 # 280 # 320 # 400 # 600 # 800 # 3500
220 # 280 # 320 # 400 # 600 # 800 # Extra Engineered

Grit size suggested sequences for Arris

Granite, Marble and Engineered Stone

3 polishing heads machine (metal + 2 polishing)
2 polishing heads machine
1 polishing head machine

Metal# 400 # 600#
220# 400#
220#

BLADES FOR DRY CUTTING

GRANITE WITH PERFORATED BODY MODEL D

Diameter	H	Flange	T	X	Code	Price
115	22,2	-	2,1	10	DDSS00043	€ -
125	-	M14	2,1	10	DDSS00044	€ -
150	-	M14	2,1	10	DDSS00045	€ -
180	-	M14	2,4	10	DDSS00046	€ -
230	22,2	-	2,6	10	DDSS00047	€ -
230	-	Passing	2,6	10	DDSS00048	€ -



GRANITE WITH LATERAL REINFORCEMENT MODEL DR

Diameter	H	Flange	T	X	Code	Price
115	22,2	-	2,2	10	DDSS00049	€ -
115	-	M14	2,2	10	DDSS00050	€ -
125	-	M14	2,4	10	DDSS00051	€ -
150	-	M14	2,2	10	DDSS00052	€ -
180	-	M14	2,6	10	DDSS00053	€ -
230	22,2	-	2,6	10	DDSS00054	€ -
230	-	Passing	2,6	10	DDSS00055	€ -



GRANITE CURVED BLADES

Diameter	H	Flange	T	X	Code	Price
125	22,2	-	3	7	DDSS00058	€ -
180	22,2	-	3	7	DDSS00059	€ -



MARBLE ELECTROPLATED

Diameter	H	Flange			Code	Price
125	-	M14			DDSS00023	€ -
150	-	M14			DDSS00024	€ -
180	-	M14			DDSS00025	€ -
230	-	Passing			DDSS00026	€ -



GRES WITH CENTRAL REINFORCEMENT

Diameter	H	Flange	T	X	Code	Price
115	22,2	-	1,2	7	DDSS00057	€ -



TURBO CUP WHEEL WITH ALLUMINIUM BODY

Diameter	H	Flange			Code	Price
100	-	M14			DDSS00060	€ -



BLADES FOR INTERMAC CNC
DIAMETER 180 MM FOR SHAPED CUT

Material	H	T	Z	V	Noiseless Body	Code	Price
Granite	30+4F	4	16	15°	no	DDSG00099	€ -
Granite	30+4F	4	16	30°	no	DDSG00102	€ -

Machine / Aggregate code	
Master 23-33-43 / P6314P0027 35-45-55-65 / P6314P0045	Master
Master 23-33-43-53-63-JET-PRO / P6314P0028 35-45-55-65 / P6314P0045	Master

DIAMETER 200 MM

Material	H	T	Z	X	Noiseless Body	Code	Price
Granite	30+4F	3	17	10	no	DDSG00103	€ -
Marble	30+4F	2,8	17	7	no	DDSM00047	€ -

Machine / Aggregate code	
Master 23-33-43-53-63 / P6314P0015 35-45-55-65-JET-PRO / P6314P0063	Master
Master 23-33-43-53-63 / P6314P0015 35-45-55-65-JET-PRO / P6314P0063	Master

DIAMETER 250 MM

Material	H	T	Z	X	Noiseless Body	Code	Price
Granite	30+4F	3	17	10	si	DDSG00042	€ -

Machine / Aggregate code	
Master 23-33-43-53-63 / P6314P0015 35-45-55-65-JET-PRO / P6314P0063	Master

DIAMETER 350 MM

Material	H	T	Z	X	Noiseless Body	Code	Price
Granite	50+6F	5	21	10	si	DDSG00022	€ -
Marble	50+6F	3,4	25	7	si	DDSM00032	€ -

Machine / Aggregate code	
Master 35-45-55-65 / P6314P0021	
Master 35-45-55-65 / P6314P0021	

DIAMETER 500 MM

Material	H	T	Z	X	Noiseless Body	Code	Price
Granite	75+6F	3,6	30	12	si	DDSG00058	€ -
Marble	75+6F	4,4	36	7	si	DDSM00052	€ -

Machine / Aggregate code	
Master 45 Plus - Top Master / P6314P0042	
Master 45 Plus - Top Master / P6314P0042	

DIAMETER 625 MM

Material	H	T	Z	X	Noiseless Body	Code	Price
Granite	60+4F	5	36	10	si	DDSU00331	€ -
Granite	60+4F	5,5	36	10	no	DDSU60020	€ -
Marble	60+4F	5,5	42	7	si	DDSU00190	€ -

Machine / Aggregate code	
Master 850 - 1200 - Master Saw 625 double table	
Master 850 - 1200 - Master Saw 625 double table	
Master 850 - 1200 - Master Saw 625 double table	

Per taglio inclinato / For inclined cut

DIAMETER 230 MM FOR CUT 44 DEGREES

Material	H	T	Z	X	Noiseless Body	Code	Price
Granite	30+4F	3	17	10	no	DDSU00099	€ -

Machine / Aggregate code	
Aggregate PCC4005019	

DIAMETER 150 MM FOR RODDING CUT

Material	H	T	Z	X	Noiseless Body	Code	Price
Granite	22+6F	4	11	10	no	DDSU00381	€ -

Machine / Aggregate code	
Aggregate PCC4005017	

The enclosed price list cancels and replaces all previous prices in your hands. Diamut reserves the right at any time to alter this document without any notice whatsoever. All prices are without taxes and are quoted ex-works, transport and insurance not included. The prices indicated can change trough out the year. Always check prices on order confirmation.

Diamut
Via Malpighi, 8 48022 Lugo
(RA) Italy
Tel. +39 0545 211911
Fax: +39 0545 25406
sales@diamut.com
P.IVA e C.F. IT 00113220412

diamut.com